

SAUNOVA **2.0** BUILT-IN
(SAU-B-V2)

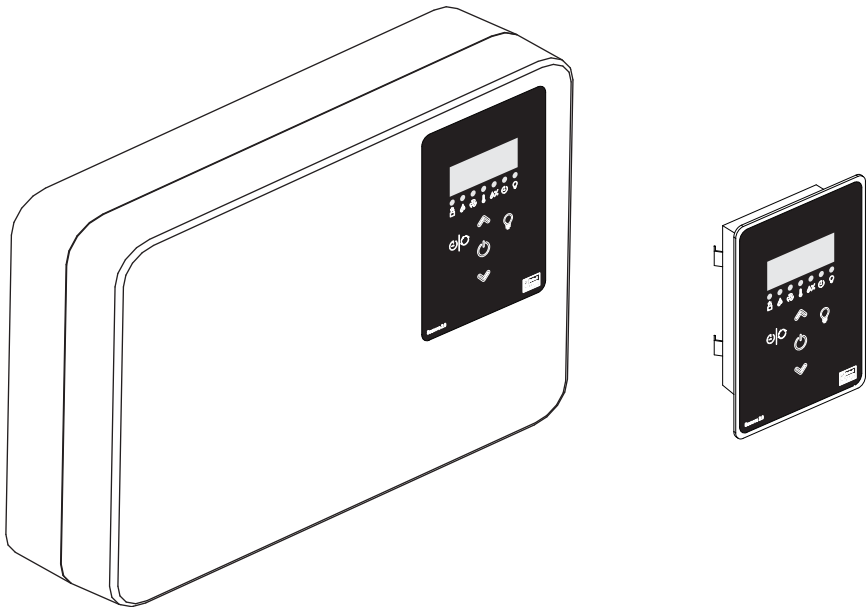

**Congratulations on your purchase of Saunova 2.0 Control Unit!
Please read the manual carefully before using the control.**

Not for use in the USA, Canada and Mexico.

ENGLISH

TABLE OF CONTENTS

1. Introduction of the Saunova 2.0 Control	3
1.1 Precautions.....	3
2. Operating Instructions	4
2.1 Quick Start	4
2.2 Directions of Use	5
2.2.1 Heater on	5
2.2.2 Heater off	5
2.2.3 Pre-run Button	5
2.2.4 Setting Mode	6
2.2.5 Fan (Optional)	6
2.2.6 Cabin Light Button.....	6
2.2.7 Key Pad Lock.....	6
2.2.8 Temperature Unit Conversion.....	6
2.3 Steamer Functions.....	6
2.3.1 Steamer	6
2.3.2 Water Refill	7
2.3.3 Cabin Drying	7
3. Assembly and Installation	8
3.1 Control Unit to Heater Connection Diagram.....	8
3.2 Power Controller	9
3.3 Contactor Unit.....	9
3.4 Technical Diagram	10
3.5 Sensors.....	12
3.5.1 Sensor location with heaters mounted on the wall	12
3.5.2 Sensor location with heaters mounted on the floor.....	13
3.6 Maximum Session Time	13
3.7 Door Sensor/Switch (Optional).....	14
3.8 Fan.....	14
3.9 Installation of Power Controller	14
3.10 Installation for Separate User Interface.....	15
3.11 The Power Controller Main Switch	15
4. DIP Switch	16
4.1 DIP Switch Functions	16
4.1.1 Safety Switch	16
4.1.2 Door Switch	16
4.2 Sessiion Time.....	16
5. Troubleshooting	17



READ THE MANUAL FOR
ADDITIONAL IMPORTANT
INSTRUCTIONS



COVERING THE HEATER
CAUSES FIRE HAZARD

1. INTRODUCTION OF THE SAUNOVA 2.0 CONTROL

Congratulations on your purchase of Saunova 2.0 Control Unit!

Saunova 2.0 Control Unit is developed to enhance your sauna bathing with a variety of different features. It can adjust temperature, humidity, ventilation and light in your sauna. The Saunova 2.0 Control Units are available on a separate or built-in mounting on the Power Controller.

The following information provides you with instructions on adjusting the settings of the control unit. Please, read this instruction manual carefully before using it. Familiarization of key functions will give you a more enjoyable sauna experience.

1.1 Precautions

1. Only a qualified electrician is allowed to make electrical connections and repairs on the unit. Use original parts only.
2. Disconnect the Power Controller and the Contactor Unit from the electrical circuit before installation, opening the lid of the power controller or contactor unit and repair.
3. Check power supply rating before installation.
4. Check the correct location of the sensor in the installation section of the manual. It is very important to place the temperature sensor correctly as its closeness to the air ventilation cools down the sensor and may lead to overheating.
5. The power controller can be operated in a room temperature 0-40°C. Do not install it inside the sauna room!
6. Do not pour water in the control unit or clean it with a wet cloth. For cleaning purposes, use a cleaning cloth that has been only slightly moistened with a mild soapy solvent (dish detergent).

Buttons and States (Illustration)

For illustrative reference only.



2. OPERATING INSTRUCTIONS

2.1 Quick Start

1. Switch the power “ON” by pressing the Power button. The set temperature will be displayed for 5 seconds followed by the actual temperature inside the sauna room.
2. Press arrow keys to adjust temperature.
3. To change the parameter values, press the Mode button.
4. Now the corresponding LED is blinking faster. Use the up and down arrows to change the values.
5. You can move from one parameter to another by short pressing the Mode button.
6. Confirm the settings by long pressing the Mode button. If no keys are pressed after 5 seconds, the control unit will confirm the changes automatically.
7. It usually takes around 25-40 minutes for the sauna to get warm. After this you can start to use your sauna.

2.2 Directions of use

2.2.1 Heater on

Press the Power button to activate the heater. The heater LED is illuminated indicating that the heater is turned on.

The sauna will heat up to the temperature of the previous setting and operate for the length of previous session time. Session time is saved for next session only if session time is changed within 5 minutes after switching the heater on.

WARNING

Always check that there is no combustible material, like towels, above the heater, nor inside the safety distances, before switching the heater on! The safety distances are stated in the heater manual.

2.2.2 Heater off

Turn the heater off by pressing the Power button. This button will turn off all the active functions, including the pre-run session. However, the sauna room light will not be switched off. Light button can be used even the heater is off. Also Fan.

2.2.3 Pre-run button

Pre-run button can only be enabled in Off Mode. During the pre-run, parameter values can be changed.

Set the pre-run time by pressing the Pre-run button. A countdown time is displayed. Use the Up and Down arrow keys to change the pre-run values. After pre-run time expires, the control will be in On Mode where heater is switched on.

Next, temperature, fan*, steamer* and session time (*not in all models) can be changed if preferred. Finally long press the toggle button to confirm.

When the control unit is in the pre-run state, it will display the remaining time of the pre-run. The confirmed pre-run settings are saved for the next session.

The pre-run function has different default settings, depending on the installation location. For domestic use, the default time is 6 hours, including the pre-run time as well as the session time.

2.2.4 Setting Mode

Press the Mode button to activate setting mode. It can be used to select and adjust the fan*, temperature, humidity* and the session time (*not all models have all the same features). Corresponding LEDs will be blinking on each selected features. Change values by pressing the up and down buttons.

Save the settings by long pressing the toggle button, a high beep will confirm it. If no keys are pressed within 5 seconds, the control unit will save the settings.

2.2.5 Fan (optional)

While in Setting Mode, short press the toggle button to select Fan. Use arrow Up or Down to switch on/off Fan. Also during OFF mode.

2.2.6 Cabin Light Button

Cabin light can be switched on, even when the heater or pre-run timer are off. Short press the button and the lights will be switched on/off.

LED for the light indicates if the light is switched on or off.

2.2.7 Key pad lock (to prevent unauthorized changing of settings)

In order to enable/disable key lock, the user interface needs to be in ON mode.

Lock the key pad by pressing the up and down arrow keys at the same time for more than 5 seconds. A high beep will confirm the activation and the deactivation.

When key lock is activated only heater on/off and cabin light functions can be used. Toggle button is enabled only to see actual values. If other buttons are pressed, “----” is shown in the display.



Unlock the buttons by pressing up and down arrow keys at the same time for more than 5 seconds. A high beep will confirm it.

The key lock function is set automatically if it was activated during the previous operation.

2.2.8 Temperature Unit Conversion

In Off mode, change to Celsius or Fahrenheit by pressing same time the Power and Arrow Down button. A beep will confirm the change and will prompt either of which is on.

In On mode, press same time the Toggle and Arrow Up button. A beep and display will confirm the change.

2.3 Steamer Functions

2.3.1 Steamer

The steamer function can only be activated if the heater has a steamer also known as combi heater and the steamer feature is present on the controller. When there is no steamer present, all the functions and settings regarding the steamer are not available.

Press the mode button to select steamer. Use the UP & DOWN keys to switch ON/OFF steamer. Long press MODE button to confirm or wait for 5 seconds that it will save. Once activated, the steamer is switched on, unless the temperature or the relative humidity inside the sauna room is too high. High humidity and high temperature are not allowed, “HOT” will be displayed in the control unit and the steamer will not be activated.

The state for “HOT” depends on the second sensor, the bench sensor. If it is a temperature sensor only, and the bench temperature in the sauna room is 56°C or more, the steamer cannot be activated. With the temperature sensor, the user can choose the relative time for the steamer to be on, within 30-100% of the session time.

However, if the second sensor is combined temperature humidity sensor, the maximum bench temperature for the steamer to work is 80°C, as long as the relative humidity in the sauna room is not too high. With the combined sensor, the user can choose the relative humidity inside the sauna room.

2.3.2 Water refill

When the water level is low, a low tone interval beep and “FILL” will be displayed to alarm the user. There are two possible ways to fill water levels, automatically or manually, depending on the model.

The auto Combi heater has a solenoid valve, which will automatically react to the low level of water. The water inlet will open to fill up the tank and steamer session can be continued without intervention.

In the manual fill, the alarm beeps and “FILL” will be displayed as long as the user fills the tank.

However if the user does not refill the tank and it becomes empty, a high tone interval beep and “dry” display will alarm the user. The steamer will automatically be switched off now, only the heater will be working.

The automatic refill mode will refill itself now, if it did not refill its tanks earlier. Always check that the water supply is open before using the automatic refill Combi heater!

2.3.3 Cabin drying

10 minutes after the steamer session, the heater will automatically dry the sauna room. The cabin drying is set to 30 minutes at 70°C; The total drying state will take 40 minutes. The remaining cabin drying time will be displayed on the interface screen.

If the steamer operation is changed to heater only, there will be no cabin drying at the end of the session.

The cabin drying session can be stopped earlier by pushing the power button.

3. ASSEMBLY AND INSTALLATION

The Saunova Control Unit consists of the Saunova Control Unit Interface, Saunova Power Controller and Sensor. The Control Unit Interface and Power Controller communicate by using RJ cable.

3.1 Control Unit to Heater Connection Diagram

Fig. 1

NOTE!
Saunova 2.0 user interface can be installed either inside or outside the sauna room. Only one user interface can be used to control the heater.

NOTE!
If the Saunova 2.0 user interface is installed inside the sauna room, none of its components should not be installed higher than 800mm from the floor.

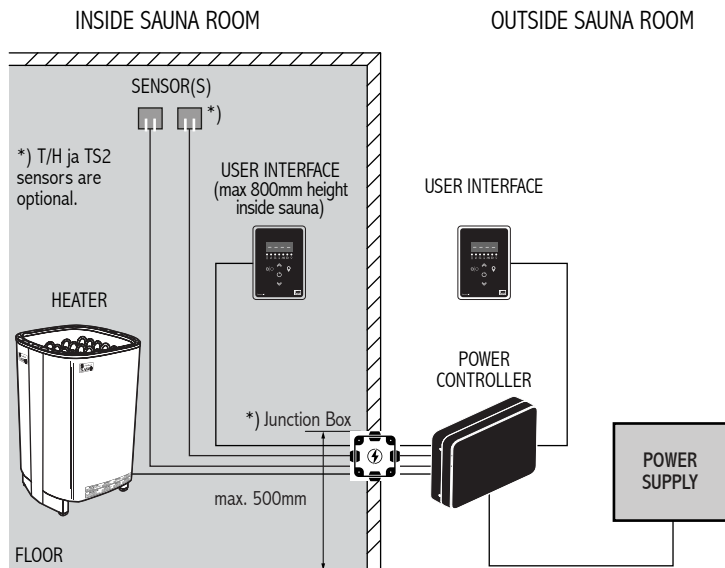

*) Follow local regulation of the junction box's location.

CABLE INSTALLATION

NOTE!
RJ cable must be embedded inside or behind the insulation.

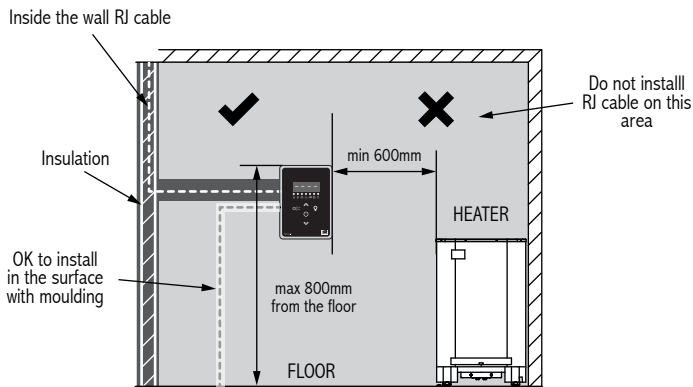

3.2 Power Controller

The Power controller must not be located inside the sauna room or in places where temperature can exceed 40°C. It is protected against water splashes, however it should not get in contact with water. Mount the Power Controller in a dry location, outside the sauna room.

The heater is connected to the electrical network semi-stationarily with a H07RN-F rubber cable or its equivalent. The use of PVC-insulated cable as a connecting cable is prohibited due to thermal embrittlement. The maximum distance of the junction box from the floor is 500 mm, measured from the upper corner of the box.

Fig. 2

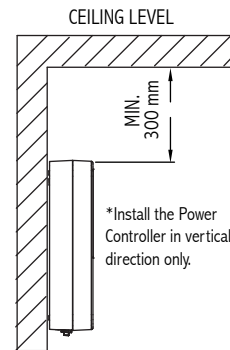
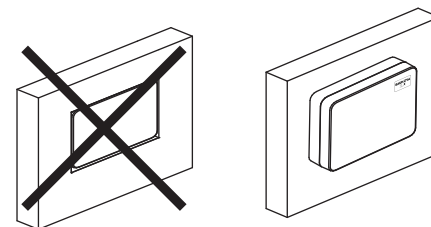

Fig. 3



WARNING !
Do not embed the control unit into the wall, because it may lead to overheating of the unit and cause damage!

3.3 Contactor Unit

If the heater used is more than 9 kW, an additional contactor is needed. The contactor unit is linked to the main Power Controller with RJ12 cable (Fig.4).

Follow the instructions that are supplied together with the contactor unit.

Fig. 4

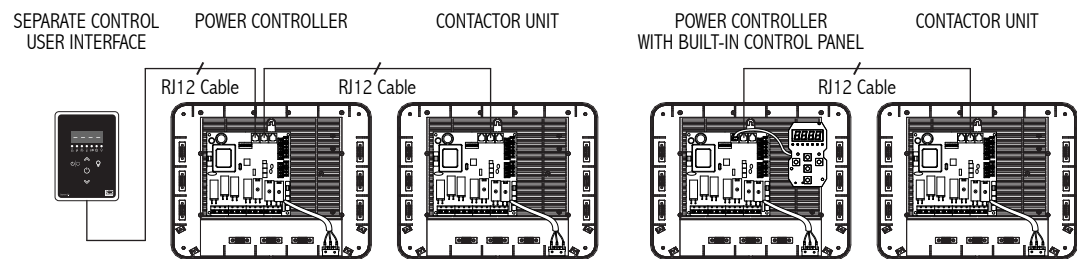

3.4 Technical Diagram

Fig. 5

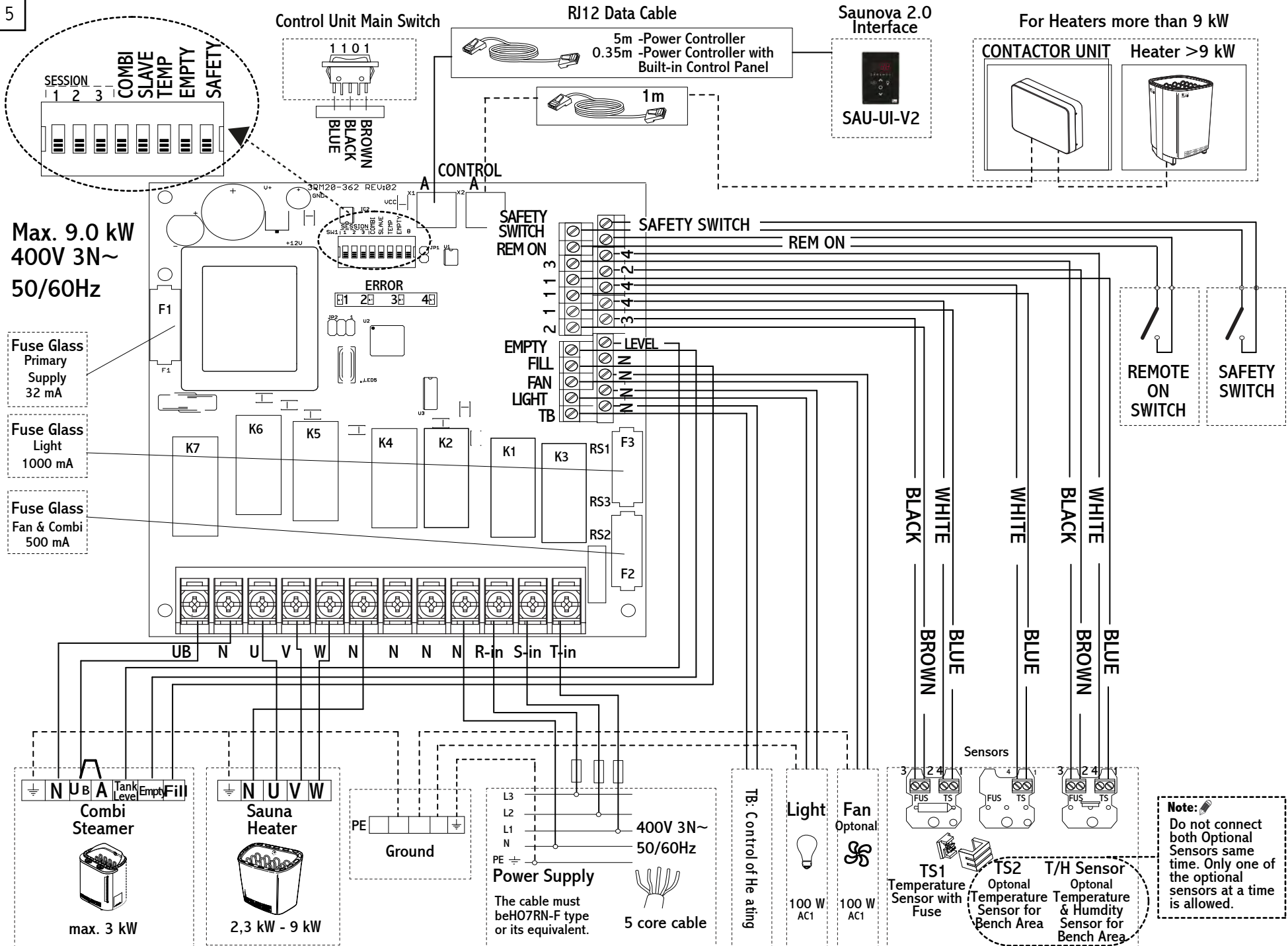

3.5 Sensors

One or two sensors can be connected to the Power Controller. The first sensor measures the temperature, it is the sensor with temperature fuse and thermistor.

The second sensor, the optional bench sensor, is a temperature sensor or combined temperature humidity sensor. The combined sensor is capable of measuring the humidity as well as the temperature.

With two sensors it is possible to receive more accurate measurements from the sauna room.

If the heater is mounted on the wall or floor standing less than 200mm from the wall, the first temperature sensor needs to be

3.5.1 Sensor location with heaters mounted on the wall

Fig. 6

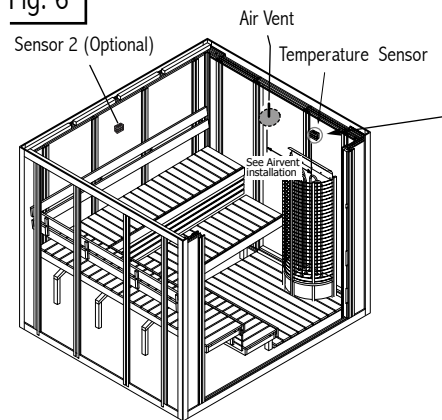
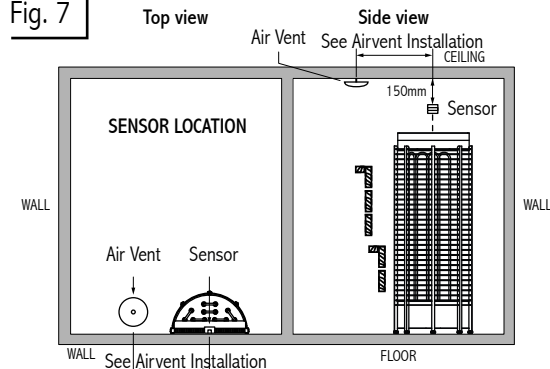

Fig. 7



mounted on the wall above the heater. Place the sensor 150mm from the ceiling (Fig. 6 & 7).

However, if the heater is more than 200mm from the wall, place the sensor to the ceiling, over the heater, as shown in the figure 8 & 9.

The optional second sensor should be mounted on the wall, opposite to the heater, minimum 30cm from the ceiling and minimum 130cm from the floor (fig 6 & 8). It is designed to measure the bench temperature, so ideally place it close to the shoulder height of the sauna goers.

Do not place the sensors near the air ventilation. The closeness of the air vent cools down the sensor. Thus, an incorrect temperature is displayed and the heater may overheat (Fig.9).

TEMPERATURE SENSOR WITH FUSE ON THE WALL

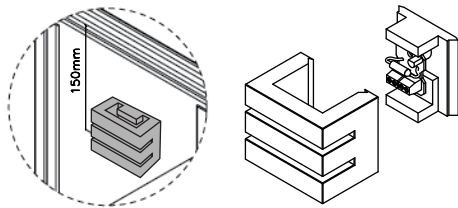

NOTE

Do not place the sensors too near to air ventilation (not under 1000mm) or not under 500mm from air ventilation, which is directed away from sensors.

AIR VENT INSTALLATION

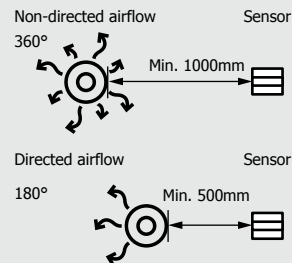

3.5.2 Sensor location with heaters mounted on the floor more than 200mm from the wall

Fig. 8

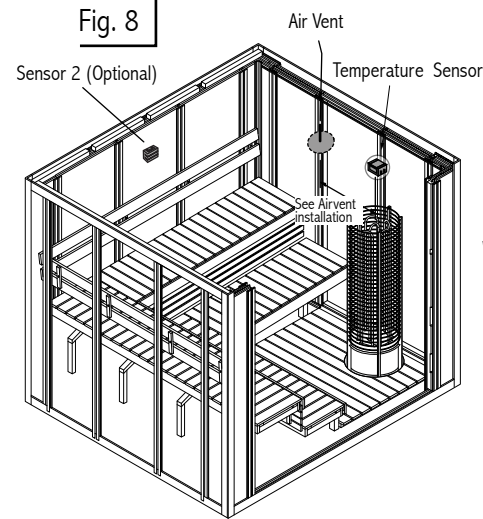
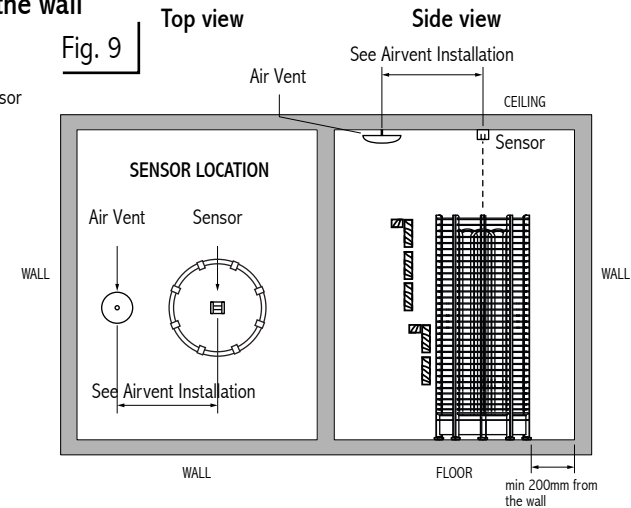

Fig. 9



3.6 Maximum Session Time

The maximum sauna session time depends on the purpose of the sauna. For domestic use, the total on-time of the sauna is limited to 6 hours. *)It includes pre-run time and the session time. The factory setting for the control unit is 6 hours.

For condominiums, hotels and similar locations, the operating period of the sauna heater is limited to 12 hours, including the pre-run time and the session time.

For public sauna, the operating period of the sauna heater can be either 18 or 24 hours. Please note, if the switches is set to

*) IEC 60335-2-53

Fig. 10

Sauna Type	Domestic sauna				Hotels, Condominiums		Public sauna	
DIP switch 1,2,3	001	010	011	000	100	101	110	111
Max. time	1h	2h	4h	6h	8h	12h	18h	24h
	Sauna on-time				Heater on-time		Session time	
Max. pre-run time	5h 15min-sauna 5h 45min-sauna				99h			

24 hours, it will be ON constantly. It needs to be continuously monitored.

The maximum heater on-time is set by the switches on DIP switch in the power controller, Figure 11 (See also DIP switch session time settings (4.2) in page 16. Only a qualified electrician can change the settings. The standards and regulations of the country where the control unit is installed must be followed when setting the DIP switch. Default time is 6 hours. See the Figure 10.

Fig. 11

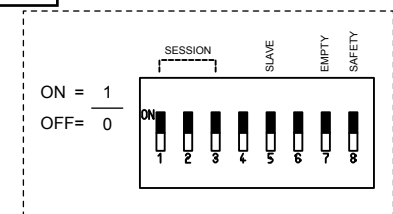

3.7 Door Sensor/Switch

In other than household use, it is recommended to install door sensor. The door sensor disables all pre-run operations if the door is opened while the pre-run countdown is active.

The door sensor also ensures that the door is not open for long periods of time when the heater is on. If the heater is on and the door is

open for more than 15minutes, an alarm and "oPEn" will be displayed to warn the user. The heater will be switched off automatically.

3.8 Fan

The fan can only be turned on and off if the fan feature is present on the control unit. Fan can be switched On/Off. The maximum power is 100W with 230 VAC.

3.9 Installation for power controller (Figure 12.)

Follow the steps in the illustration below. Before installation, please read first chapter 1.1 Precautions.

1. Install power controller outside sauna room in a dry place, where temperature will not exceed +40C and condense of water is not possible inside the controller.
2. Unscrew four screws from the top cover.
3. For built-in control, disconnect the RJ cable from the user interface or from the power controller before lifting the top cover.
4. Insert the designated wires to corresponding terminals. See Technical Diagram.
5. Drill holes for the screws on the wall as where to attach the power controller. Install the power controller in vertical direction only. Follow the measurements given.
6. Close the cover after the wiring connections have been made. Screw the four screws back to the top cover.

Fig. 12

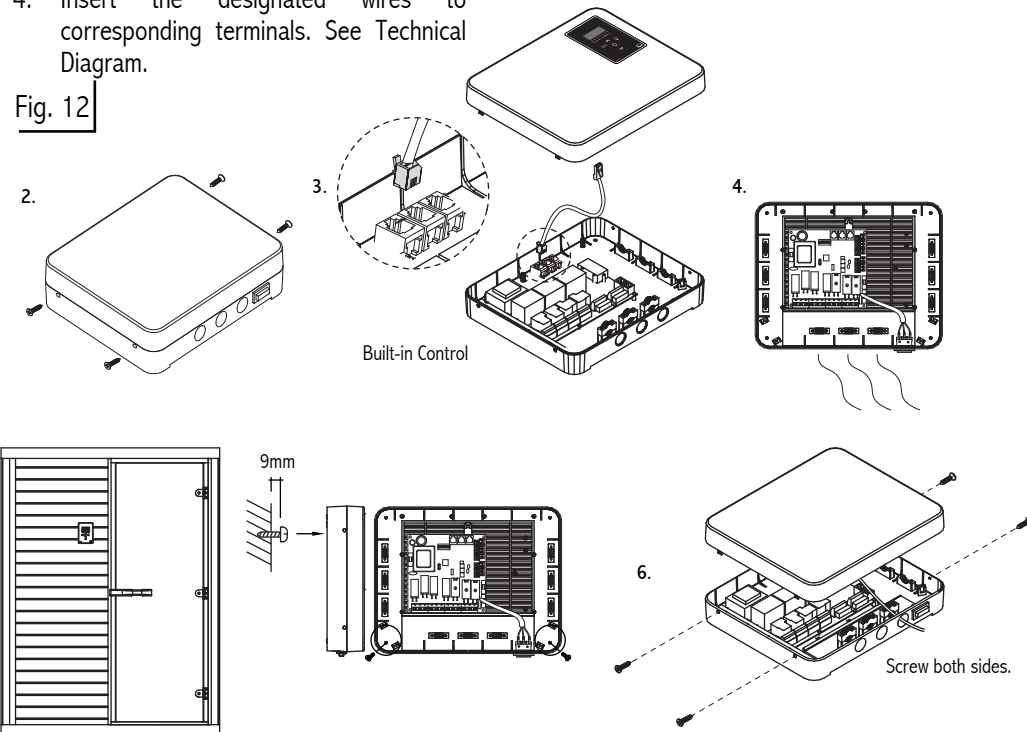

3.10 Installation for Separate User Interface (See Illustration)

1. Mount the separate control panel in you preferred location. Make sure that the installation location follows the min and max values in below image if the separate control panel is installed inside the sauna room.
2. Cut the wall section according to the specifications.
3. Connect the RJ cable provided from the control panel to the Power Controller.
4. Insert the casing on the cut section.
5. Screw the Control panel to the wall on the holes provided.
6. Snap the top cover of the panel to its place.

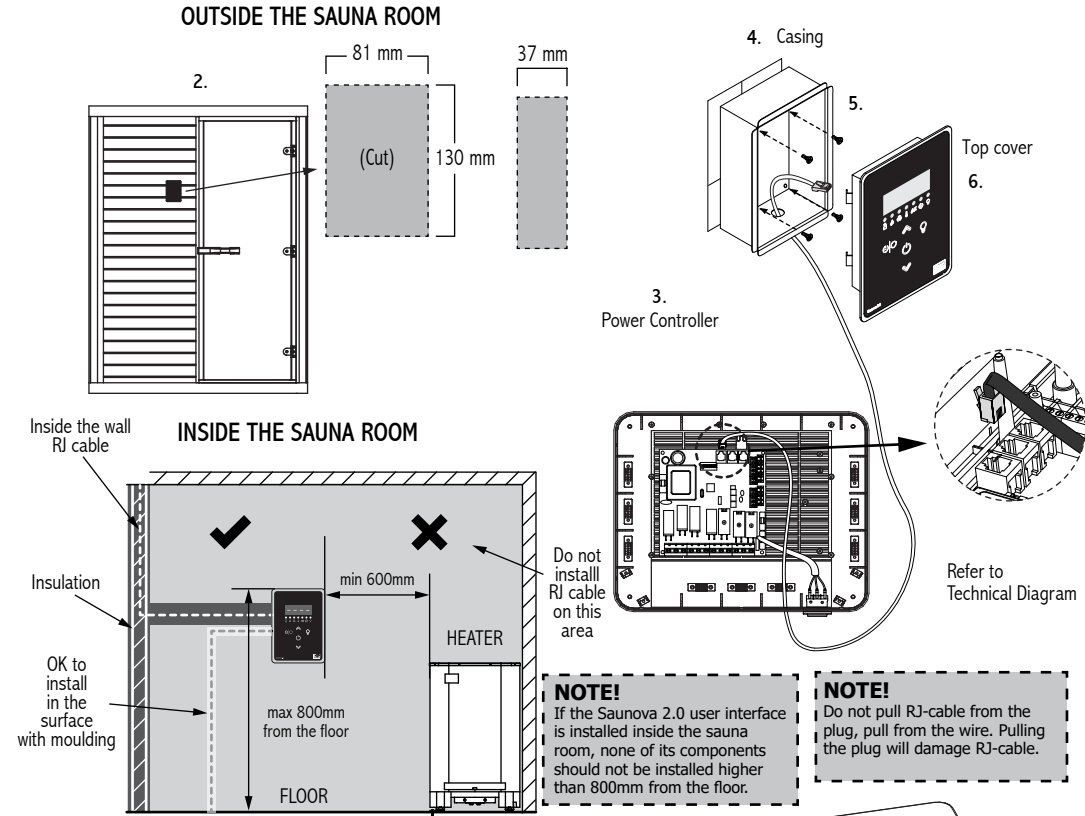

3.11 The Power Controller Main Switch

The power controller switch can be found on the top end of the unit. Using this switch, you can isolate the electronics from the mains power supply.

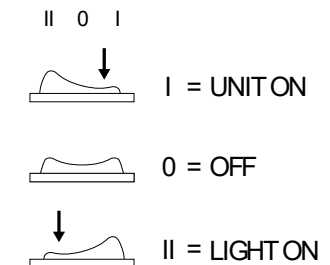
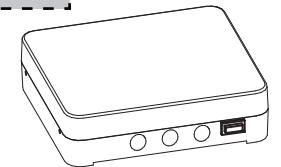

4. DIP SWITCH

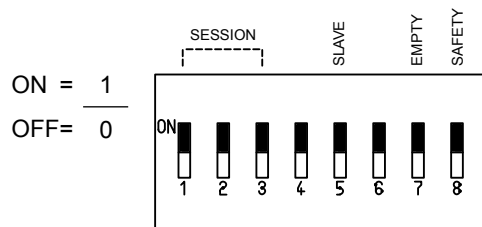

4.1 DIP Switch Functions

DIP Switch #	Function	ON	OFF
1	Session time		
2	Session time		
3	Session time		
4	Combi mode	Combi mode ON	Combi mode OFF
5	Slave	Contactor	Controller
6	-	-	-
7	Empty	Combi heater with 1 signal (Wm) for water level detection	Combi heater with 2 signal (Empty & Level) for water level detection
8	Safety/door switch	*Safety switch	**Door sensor/switch

In DIP switch #8, the Safety Switch function is available when it is switched ON and Door Switch function when it is OFF. Both functions cannot work at the same time.

*Safety Switch

The safety switch function is for a triggering device that will cut the heater connection when a combustible foreign object is thrown to the heater.

When Safety switch is open, the Safety switch is considered to be close, and when Safety switch is closed the Safety switch is considered to be open.

**Door Sensor/Switch

Install a door sensor and connect it to the control. A signal is channel to the control when the door is open. The control will switch OFF when the door is open during PRE-RUN. When the control is in ON MODE and the door was left open for more than 15mins, the control will switch OFF and turn ON again when the door is close.

When door sensor/switch is open the door is considered to be close, and when door sensor/switch is closed the door is considered to be open.

Session Time

Session time can be set according to user preference by session dip switches on the power controller board.

Session Time	Switch 1	Switch 2	Switch 3
1h	0	0	1
2h	0	1	0
4h	0	1	1
6h	0	0	0
8h	1	0	0
12h	1	0	1
18h	1	1	0
24h	1	1	1

5. TROUBLESHOOTING

If an error occurs, the heater will be switched off. There will be a warning beep and the code for the error will be displayed in the control panel.

WARNING

Please note, only a qualified electrician or maintenance personnel is allowed to make the service operations and repairs!

See more details on the table below.

Table 2

Code	Problem	Solution
E1	Temperature sensor 1 is not connected.	Check the wire between the sensor and the control unit. If there is no problem with the wires and they are correctly installed, check the sensor.
E2	Temperature sensor 1 is short circuit.	If no reason for the problem can be found, contact the retailer.
E3	Temperature fuse is defective.	Check the thermal fuse if it's not overheated & has continuity . Check the wire between the sensor and the control unit.The reason for it needs to be discovered before using the sauna again. A new sensor is needed. If no reason for the problem can be found, contact the retailer.
E4	Temperature sensor 2 is not connected.	Check the wire between the bench sensor and the control unit. If there is no problem with the wires and they are correctly installed, check the sensor. The heater can still be used with the sensor 1 only but 2 sensors are needed for the steamer.
E5	Temperature sensor 2 is short circuit.	If a new sensor is needed or no reason for the problem can be found, contact the retailer.
E6	Combined Temperature / Humidity sensor is defective.	
E7	Communication failure.	Check the RJ cable. If the area where the cable is located has many other cables, it can cause interference problems. Make sure that only one main board is set to Power Controller and the rest are Contactor Unit. Check DIP switch setting. If no reason for the problem can be found, contact the retailer.
E8	Temperature is greater than the maximum temperature.	If this happens contact qualified electrician or maintenance personnel before using the sauna again.
oPEn	Safety Switch open or Door sensor open.	Remove object on the top of the heater or close the Door sensor.
E10	PCB overheat.	Check ventilation of power controller. Heater will turn back ON if power controller already cool-down.

Other possible problems are:

- The control unit is working fine, but the heater does not turn on. Check the electricity supply to the heater. Check that the wires for the sensors are placed into the correct terminals in the control unit.
- The control unit cannot display the relative humidity* (only when the combined sensor is installed). The combined sensor cannot be recognised. The wires for the sensor are placed in the wrong terminals.
- Control unit doesn't turn on and clicking sound can be heard. Check that fuse F1 (near transformer) is tightly in fuse holder.
- User presses a button and "----" is shown in the display. This indicates that the key pad is locked. Unlock the buttons by pressing up and down arrow keys at the same time for more than 5 seconds. A high beep will confirm the activation and the deactivation.
- The steamer is on and "dry" is displayed, even though there is plenty of water in the tank. Make sure that terminals "empty" and "tank level" are correctly connected to the right terminals in the Power Controller.
- The steamer is switched on and "dry" is displayed immediately. Make sure that the "WB" terminal from the heater is connected with the "tank level" in the Power Controller. Switch On DIP switch number 7 (empty) to disable empty function.
- When the user turns the steamer on and "Fill" is displayed continuously, the wiring needs to be checked. Switch On DIP switch number 7 (empty) to disable empty function. In addition, the "WB" terminal from the heater needs to be connected to the "tank level" in the Power Controller.



- If error E4 or E6 is displayed, there is a problem with the bench sensor. If only one sensor is installed, the steamer cannot be used. The user can confirm the error by pressing the on/off button, after which the heater will function normally, but the steamer cannot be used.
- The user switches the steamer on and "dry" is displayed immediately. Check that the "empty" and "tank level" terminals from the heater are connected with the "empty" and the "tank level" in the Power Controller.

4 LEDs in the power controller identifies errors.

ERROR	Description	LED 1	LED 2	LED 3	LED 4
E1	Temperature sensor 1 is not connected.	0	0	0	1
E2	Temperature sensor 1 is short circuit.	0	0	1	0
E3	Temperature fuse is defective.	0	0	1	1
E4	Temperature sensor 2 is not connected.	0	1	0	0
E5	Temperature sensor 2 is short circuit.	0	1	0	1
E6	Combined Temperature / Humidity sensor is defective.	0	1	1	0
E7	Communication failure or main board is turned off while contactor is powered by rocker switch.	0	1	1	1
E8	Temperature is greater than the maximum temperature.	1	0	0	0
E9	Safety Switch open or Door sensor open.	1	0	0	1
E10	Power controller overheat.	1	0	1	0

If E9 occurs, LED screen displays "oPEn" while the LED error indicator on the power controller will blink the E9 code.

Description	Power Rating	Remarks
Control		
Rated Power 3 Phases	9kW AC1 (3 x 3kW)	
Rated Voltage 3 Phases	400V 3N~	
Rated Power Single Phase	9kW AC1	
Rated Voltage Single Phase	230V 1N~	
Frequency	50/60Hz	
Switching capacity per phase	16A	
Sauna temperature range	30-110°C	
Maximum session time (preset)	1, 2, 4, 6, 8, 12, 18, 24h	Restrictions apply according to IEC/EN 60335-2-53
Dimensions SAUNOVA 2.0 S types		
User Interface	(W) 104 x (H) 147 x (D) 37	
Power Controller	(W) 270 x (H) 320 x (D) 90	
Weight SAUNOVA 2.0 S types		
User Interface	350g	
Power Controller	2300g	
Weight SAUNOVA 2.0 B types	2500g	

Description	Power Rating	Remarks
Steamer		
Rated Power 3 Phases	3kW AC1	
Rated Power Single Phase	3kW AC1	
Rated Voltage	230V 1N~	
Switching capacity	16A (3 Phases), 16A (1 Phase)	
Maximum sauna temperature for steamer operation	80°C or *55°C * Depending on the type of Sensor 2.	
Automatic water filling		Optional
Cabin Light		
Rating	230V 1N~, 100W AC1	Min 20W, max 100W.
Fan		
Rating	230V 1N~, 0.5A	Fan without starting capacitor.
Fuse		
Fuse F1	(32mA) is fuse for electronics	
Fuse F2	(1A slow) is fuse for cabin light	
Fuse F3	(500mA slow) is fuse for fan and automatic refilling combi.	

Description	Remarks
Sensor	
Temperature Sensor with fuse	
Bench Sensors	
Bench Temperature Sensor	Optional
Bench Combined Temperature - Humidity Sensor	Optional

Description	Power Rating	Remarks
Contactor Unit		
Rated Power 3 Phases	9kW AC1 (3 x 3kW)	Additional Power expansion to maximum of 18kW
Rated Voltage 3 Phases	400V 3N~	
Frequency	50/60Hz	
Switching capacity per phase	16A	









Subject to change without notice.



www.sawo.com | info@sawo.com