

POOLEX

Véga PAC *Fi*

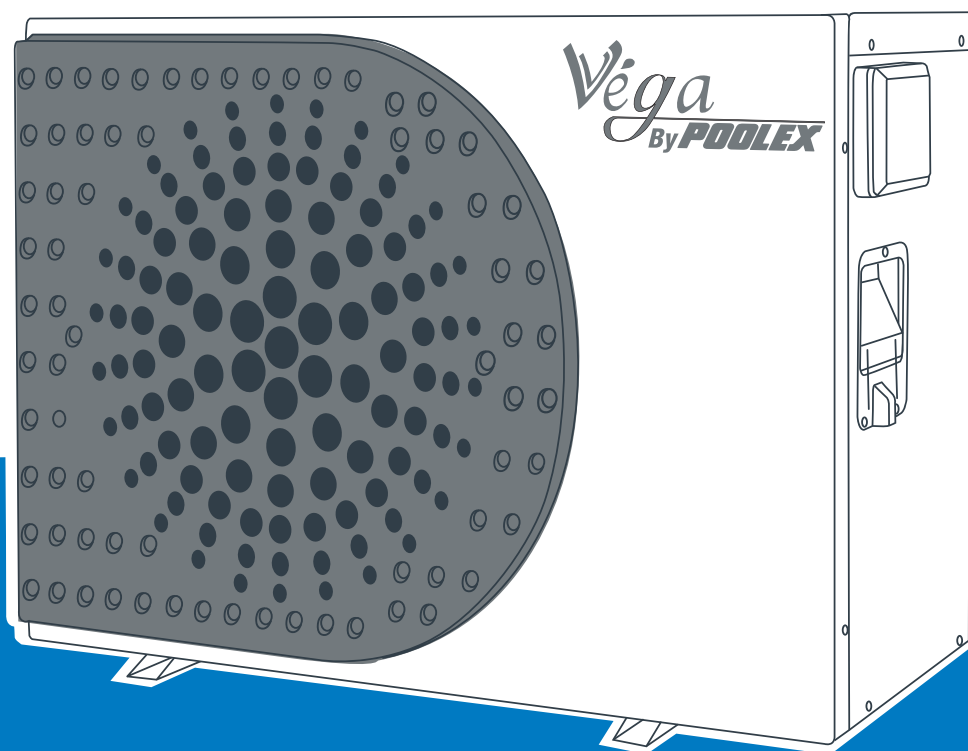

INSTALLATION AND USER MANUAL
for your heat pump

Warning



This heat pump contains a flammable refrigerant R32.

Any intervention on the refrigerant circuit is prohibited without a valid authorization.

Before working on the refrigerant circuit, the following precautions are necessary for safe work.

1. Work procedure

The work must be carried out according to a controlled procedure, in order to minimize the risk of presence of flammable gases or vapors during the execution of the works.

2. General work area

All persons in the area must be informed of the nature of the work in progress. Avoid working in a confined area. The area around the work area should be divided, secured and special attention should be paid to nearby sources of flame or heat.

3. Verification of the presence of refrigerant

The area should be checked with a suitable refrigerant detector before and during work to ensure that there is no potentially flammable gas. Make sure that the leak detection equipment used is suitable for flammable refrigerants, ie it does not produce sparks, is properly sealed or has internal safety.

4. Presence of fire extinguisher

If hot work is to be performed on the refrigeration equipment or any associated part, appropriate fire extinguishing equipment must be available. Install a dry powder or CO₂ fire extinguisher near the work area.

5. No source of flame, heat or spark

It is totally forbidden to use a source of heat, flame or spark in the direct vicinity of one or more parts or pipes containing or having contained a flammable refrigerant. All sources of ignition, including smoking, must be sufficiently far from the place of installation, repair, removal and disposal, during which time a flammable refrigerant may be released into the surrounding area. Before starting work, the environment of the equipment should be checked to ensure that there is no risk of flammability. «No smoking» signs must be posted.

6. Ventilated area

Make sure the area is in the open air or is properly ventilated before working on the system or performing hot work. Some ventilation must be maintained during the duration of the work.

7. Controls of refrigeration equipment

When electrical components are replaced, they must be suitable for the intended purpose and the appropriate specifications. Only the parts of the manufacturer can be used. If in doubt, consult the technical service of the manufacturer.

The following controls should be applied to installations using flammable refrigerants:

- The size of the load is in accordance with the size of the room in which the rooms containing the refrigerant are installed;*
- Ventilation and air vents work properly and are not obstructed;*
- If an indirect refrigeration circuit is used, the secondary circuit must also be checked.*
- The marking on the equipment remains visible and legible. Illegible marks and signs must be corrected;*
- Refrigeration pipes or components are installed in a position where they are unlikely to be exposed to a substance that could corrode components containing refrigerant*

8. Verification of electrical appliances

Repair and maintenance of electrical components must include initial safety checks and component inspection procedures. If there is a defect that could compromise safety, no power supply should be connected to the circuit until the problem is resolved.

Initial security checks must include:

- That the capacitors are discharged: this must be done in a safe way to avoid the possibility of sparks;*
- No electrical components or wiring are exposed during loading, recovery or purging of the refrigerant gas system;*
- There is continuity of grounding.*

Thank you

Dear Customer,

Thank you for your purchase and for your confidence in our products.

These are the result of many years of research in the field of design and production of heat pumps for swimming pools. Our aim is to provide you with an exceptional high performance quality product.

We have produced this manual with the utmost care so that you get maximum benefit from your Poolex heat pump.

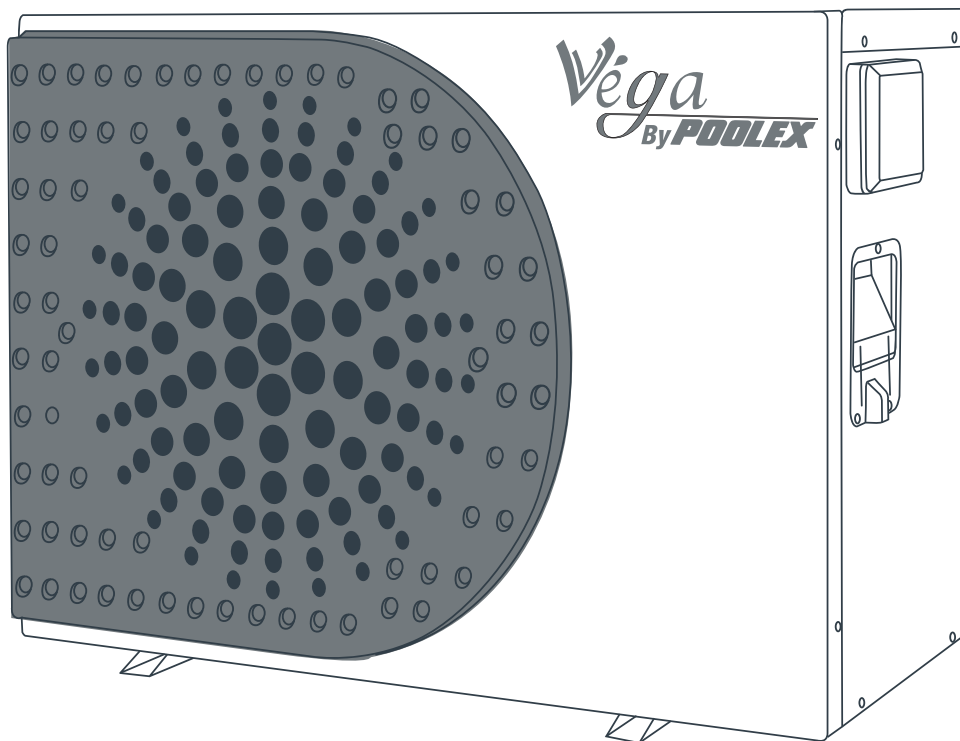



PLEASE READ CAREFULLY.



**These installation instructions are an integral part of the product.
They must be given to the installer and retained by the user.
If the manual is lost, please consult the website:**

www.poolex.fr

The instructions and recommendations contained in this manual should be read carefully and understood since they provide valuable information concerning the heat pump's safe handling and operation. **Keep this manual in an accessible place for easy future reference.**

Installation must be carried out by a qualified professional person in accordance with current regulations and the manufacturer's instructions. An installation error may cause physical injury to persons or animals as well as mechanical damage for which the manufacturer can under no circumstances be held responsible.

After unpacking the heat pump, please check the contents in order to report any damage.

Prior to connecting the heat pump, ensure that the information provided in this manual is compatible with the actual installation conditions and does not exceed the maximum limits authorised for this particular product.

In the event of a defect and/or malfunction of the heat pump, the electricity supply must be disconnected and no attempt made to repair the fault.

Repairs must be undertaken only by an authorised technical service organisation using original replacement parts. Failure to comply with the above-mentioned clauses may have an adverse effect on the heat pump's safe operation.

To guarantee the heat pump's efficiency and satisfactory operation, it is important to ensure its regular maintenance in accordance with the instructions provided.

If the heat pump is sold or transferred, always make sure that all technical documentation is transmitted with the equipment to the new owner.

This heat pump is designed solely for heating a swimming pool. Any other use must be considered as being inappropriate, incorrect or even hazardous.

Any contractual or non-contractual liability of the manufacturer/distributor shall be deemed null and void for damage caused by installation or operational errors, or due to non-compliance with the instructions provided in this manual or with current installation norms applicable to the equipment covered by this document.

Contents

1.	Generality	6
1.1	General conditions of delivery	6
1.2	Safety instructions	6
1.3	Water treatment	7
2.	Description	8
2.1	Parcel content	8
2.2	Main Features	8
2.4	Technical characteristics	9
2.5	Dimensions of the device	10
2.6	Exploded view	11
3.	Installation	12
3.1	Prerequisites	12
3.2	Site	13
3.3	Installation scheme	13
3.4	Condensate evacuation	13
3.5	Installing the device on silent media	13
3.6	Hydraulic connection	14
3.7	Electrical Installation	16
3.8	Electrical connection	17
4.	Use	18
4.1	Control box	18
4.2	Remote control display	18
4.3	Choice of operating mode	19
4.4	Setting the set temperature	19
4.5	System Settings	19
4.6	Clock adjustment	20
4.7	Setting the schedule programming	21
4.8	Locking the control box	21
4.9	Status values	22
4.10	Factory programming	22
4.11	Wireless	23
5.	Commissioning	28
5.1	Commissioning	28
5.2	Enslavement of a circulation pump	28
5.3	Using the pressure gauge	29
5.4	Antifreeze protection	29
6.	Maintenance and maintenance	30
6.1	Maintenance and maintenance	30
6.2	Wintering	30
7.	Repair	31
7.1	Faults and anomalies	31
7.2	List of anomalies	32
7.3	Inverter module errors	32
7.4	Wiring diagrams of the electronic card	33
8.	Recycling	34
8.1	Recycling the heat pump	34
9.	Guarantee	35
9.1	Terms and Conditions	35
10.	Annexes	36
10.1	Schémas de câblage de la carte électronique	33

1. General

1.1 General Terms of Delivery

All equipment, even if shipped 'free of carriage and packing', is dispatched at the consignee's own risk

The person responsible for receiving the equipment must carry out a visual inspection to identify any damage to the heat pump during transport (refrigerant system, body panels, electrical control box, frame). He/she must note down on the carrier's delivery note any remarks concerning damage caused during transport and confirm them to the carrier by registered letter within 48 hours.

The equipment must always be stored and transported vertically on a pallet and in its original packaging. If



it is stored or transported horizontally, wait at least 24 hours before switching it on.

1.2 Safety instructions



WARNING: Please read carefully the safety instructions before using the equipment. The following instructions are essential for safety so please strictly comply with them.

During installation and servicing

Only a qualified person may undertake installation, start-up, servicing and repairs, in compliance with current standards.

Before operating or undertaking any work on the equipment (installation, commissioning, usage, servicing), the person responsible must be aware of all the instructions in the heat pump's installation manual as well as the technical specifications.

Under no circumstances install the equipment close to a source of heat, combustible materials or a building's air intake.

If installation is not in a location with restricted access, a heat pump protective grille must be fitted.

To avoid severe burns, do not walk on pipework during installation, repairs or maintenance.

To avoid severe burns, prior to any work on the refrigerant system, turn off the heat pump and wait several minutes before placing temperature and pressure sensors.

Check the refrigerant level when servicing the heat pump.

Check that the high and low pressure switches are correctly connected to the refrigerant system and that they turn off the electrical circuit if tripped during the equipment's annual leakage inspection.

Check that there is no trace of corrosion or oil stains around the refrigerant components.

1. General

During use

To avoid serious injuries, never touch the fan when it is operating.

Keep the heat pump out of the reach of children to avoid serious injuries caused by the heat exchanger's blades.

Never start the equipment if there is no water in the pool or if the circulating pump is stopped.

Check the water flow rate every month and clean the filter if necessary.

During cleaning

Switch off the equipment's electricity supply.

Close the water inlet and outlet valves.

Do not insert anything into the air or water intakes or outlets.

Do not rinse the equipment with water.

During repairs

Carry out work on the refrigerant system in accordance with current safety regulations.

Brazing should be performed by a qualified welder.

When replacing a defective refrigerant component, use only parts certified by our technical department.

When replacing pipework, only copper pipes conforming to Standard NF EN12735-1 may be used for repairs.

When pressure-testing to detect leaks:

To avoid the risks of fire or explosion, never use oxygen or dry air.

Use dehydrated nitrogen or a mixture of nitrogen and refrigerant.

The low and high side test pressure must not exceed 42 bar.

1.3 Water treatment

Poolex heat pumps for swimming pools can be used with all types of water treatment systems.

Nevertheless, it is essential that the treatment system (chlorine, pH, bromine and/or salt chlorinator metering pumps) is installed after the heat pump in the hydraulic circuit.

To avoid any deterioration to the heat pump, the water's pH must be maintained between 6.9 and 8.0.

2. Description

2.1 Package contents

- ✓ Heat pump Poolex Vega
- ✓ 2 hydraulic inlet/outlet connectors (50mm diameter)
- ✓ Extension cable for remote control panel
- ✓ This installation and user manual
- ✓ Condensation draining kit
- ✓ **Winter storage cover**
- ✓ **4 anti-vibration pads (fastenings not supplied)**

2.2 General characteristics

A Poolex heat pump has the following features:

- ◆ CE certification and complies with the RoHS European directive.
- ◆ High performance with up to 80% energy savings compared to a conventional heating system.
- ◆ Clean, efficient and environmentally friendly R32 refrigerant.
- ◆ Reliable high output leading brand compressor.
- ◆ Wide hydrophilic aluminium evaporator for use at low temperatures.
- ◆ User-friendly intuitive remote control.
- ◆ Heavy duty ABS shell, anti-UV treated and easy to maintain.
- ◆ Designed to be silent.
- ◆ Dual antifreeze system to avoid frost damage:
 - Revolutionary exchanger with patented antifreeze system.
 - A smart monitoring system to preserve the pipework and liner without emptying the pool in winter.

2. Description

2.3 Technical specifications

		Poolex Vega		
Test conditions		50	70	90
Air ⁽¹⁾ 26°C Water ⁽²⁾ 26°C	Heating power (kW)	7.1~2.04	9.5~2.3	11.9~2.35
	Power in mode Silence (kW)	3.74~2.04	4.90~2.30	6.18~2.35
	Consumption (kW)	1.15~0.15	1.51~0.17	1.92~0.14
	Consumption in Silence (kW)	0.41~0.15	0.49~0.17	0.63~0.14
	COP (Coeff. of performance)	13.6~6.2	14~6.3	16.4~6.2
Air ⁽¹⁾ 15°C Water ⁽²⁾ 26°C	Heating power (kW)	5.4~1.4	6.7~1.5	8.7~1.7
	Power in mode Silence (kW)	2.80~1.40	3.65~1.50	4.53~1.70
	Consumption (kW)	1.15~0.22	1.49~0.23	1.89~0.22
	Consumption in Silence (kW)	0.44~0.22	0.57~0.23	0.69~0.22
	COP (Coeff. of performance)	6.5~4.7	6.6~4.5	7.8~4.6
Air ⁽¹⁾ 35°C Water ⁽²⁾ 27°C	Cooling capacity (kW)	3.35	4.2	5.37
	Consumption (kW)	0.84	1.08	1.31
	EER (Coeff. of performance)	4.01	3.9	4.1
Air ⁽¹⁾ 15°C Water ⁽²⁾ 26°C MODE FIX	Heating power (kW)	5.4	6.7	8.7
	Consumption (kW)	1.15	1.49	1.89
	COP (Coeff. of performance)	4.7	4.5	4.6
Maximum power (kW)		1.38	1.83	2.62
Maximum current (A)		8	10	13
Electricity supply		220~240V / 50Hz		
Protection		IPX4		
Heating temperature range		15°C~40°C		
Cooling temperature range		8°C~28°C		
Operating temperature range		-7°C~43°C		
Unit dimensions L x W x H (mm)		824*334*643		
Unit weight (kg)		35	37.5	41
Sound pressure level at 1 m (dBA) ⁽³⁾		37~50	37~51	38~52
Sound pressure level at 10 m (dBA) ⁽³⁾		19~29	19~30	21~31
Hydraulic connection (mm)		PVC 50mm		
Heat exchanger		Cuve PVC et Serpentin Titane torsadé		
Min. / Max. water flow rate (m³/h)		2~4	3~4	4~6
Compressor		Toshiba		
Compressor type		Hermetic Rotary DC Inverter Compressor		
Refrigerant		R32		
Réfrigérant mass (kg)		0.45	0.45	0.6
Fan motor		DC Fan Motor		
Load loss (mCE)		1.1	1.1	1.1
Max. pool volume (m³) ⁽⁴⁾		30-45	40-50	45-65
Remote control		Écran de contrôle LCD rétroéclairé filaire		
Mode		Eco Booster & Eco Silence (Inverter) / Chauffage / Refroidissement		

The technical specifications of our heat pumps are provided for information purposes only. We reserve the right to make changes without prior notice.

¹ Ambient air temperature

² Initial water temperature

³ Noise at 1 m, at 4 m and at 10 m in accordance with Directives EN ISO 3741 and EN ISO 354

⁴ Calculated for an in-ground private swimming pool covered with a bubble cover.

2. Description

2.4 Unit dimensions

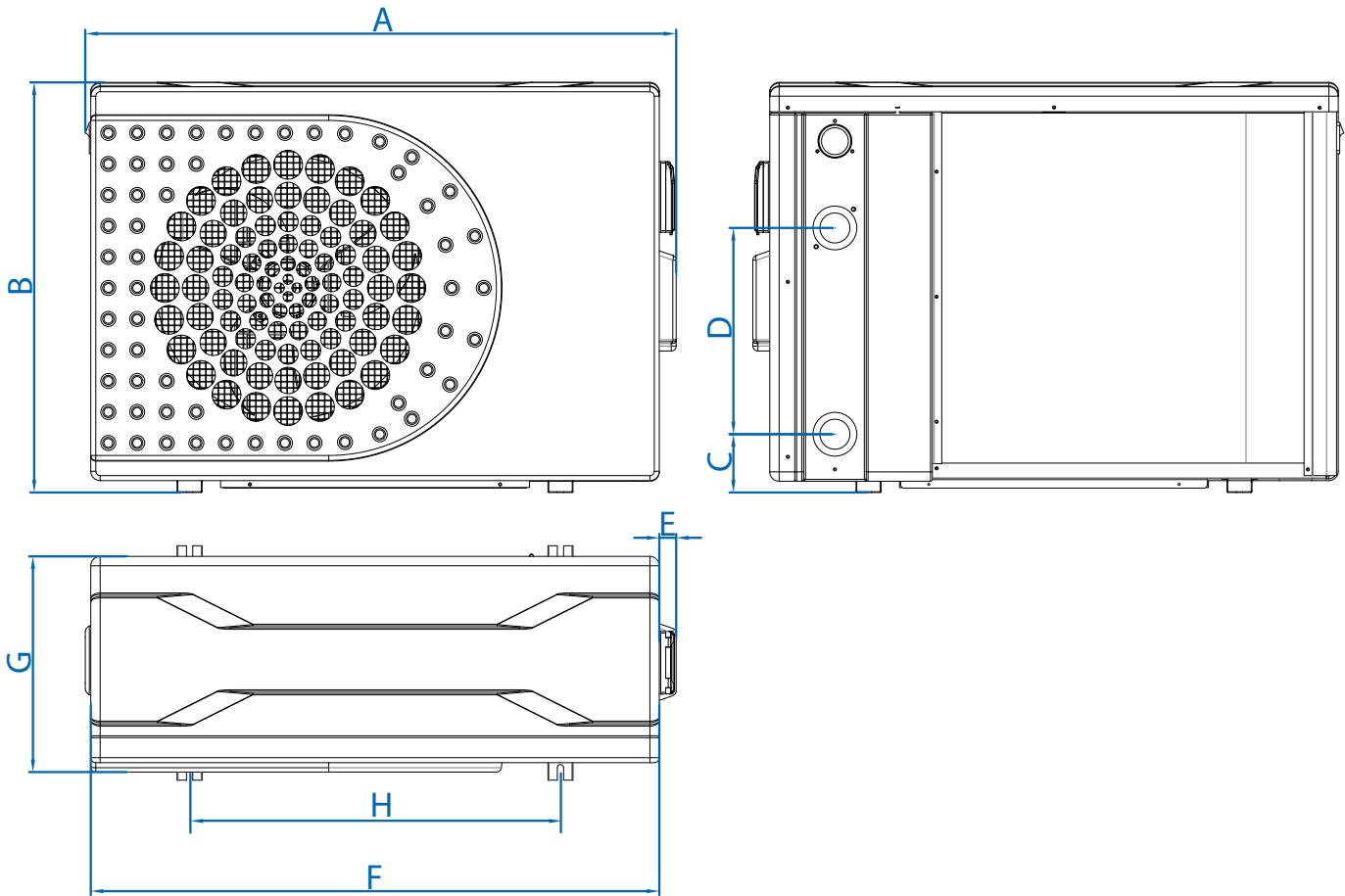

Dimensions en mm

Vega	50 / 70 / 90
A	865
B	656
C	103
D	260
E	27
F	829
G	343
H	590

2. Description

2.5 Exploded view

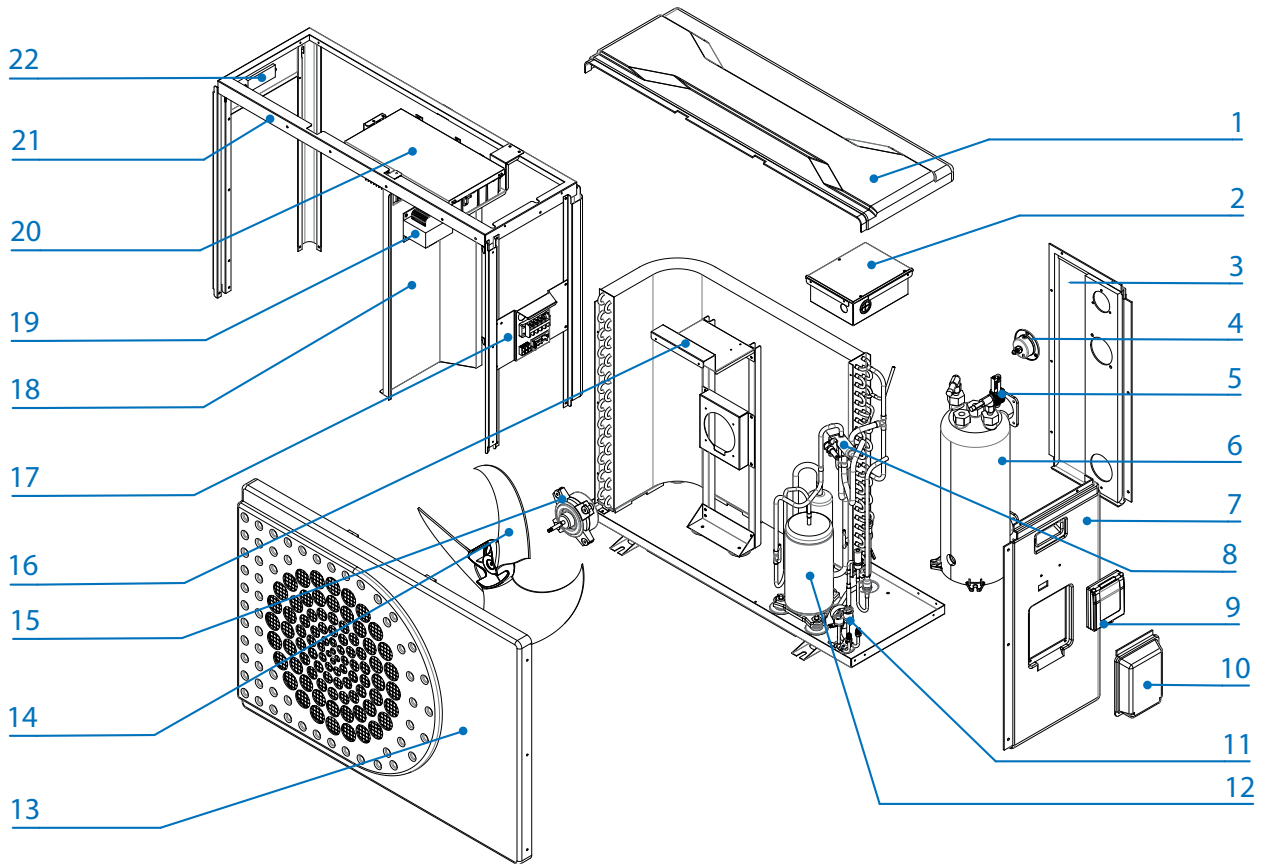

- | | |
|---------------------------|-------------------------------|
| 1. Top panel | 13. Front panel |
| 2. Logic board box | 14. Fan blade |
| 3. Back panel | 15. Fan motor |
| 4. Pressure gauge | 16. Fan support |
| 5. Water Flow Switch | 17. Electrical terminal block |
| 6. Heat exchanger | 18. Middle support |
| 7. Right side panel | 19. Electric transformer |
| 8. gas pipe | 20. Electrical control box |
| 9. Electrical control box | 21. Base frame |
| 10. Electrical box cover | 22. Right hand grip |
| 11. pressure switch hp/bp | |
| 12. Compressor | |

3. Installation



WARNING: Installation must be carried out by a qualified engineer.

This section is provided for information purposes only and must be checked and adapted if necessary according to the actual installation conditions.

3.1 Pre-requirements

Equipment necessary for the installation of your heat pump:

Power supply cable suitable for the unit's power requirements.

A *By-Pass* kit and an assembly of PVC tubing suitable for your installation as well as stripper, PVC adhesive and sandpaper.

A set of wall plugs and expansion screws suitable to attach the unit to your support.

We recommend that you connect the unit to your installation by means of flexible PVC pipes in order to reduce the transmission of vibrations.

Suitable fastening studs may be used to raise the unit.

3.2 Location

Please comply with the following rules concerning the choice of heat pump location.

1. The unit's future location must be easily accessible for convenient operation and maintenance.
2. It must be installed on the ground, fixed ideally on a level concrete floor. Ensure that the floor is sufficiently stable and can support the weight of the unit.
3. A water drainage device must be provided close to the unit in order to protect the area where it is installed.
4. If necessary, the unit may be raised by using suitable mounting pads designed to support its weight.
5. Check that the unit is properly ventilated, that the air outlet is not facing the windows of neighbouring buildings and that the exhaust air cannot return. In addition, provide sufficient space around the unit for servicing and maintenance operations.
6. The unit must not be installed in an area exposed to oil, flammable gases, corrosive products, sulphurous compounds or close to high frequency equipment.
7. To prevent mud splashes, do not install the unit near a road or track.
8. To avoid causing nuisance to neighbours, make sure the unit is installed so that it is positioned towards the area that is least sensitive to noise.
9. Keep the unit as much as possible out of the reach of children.

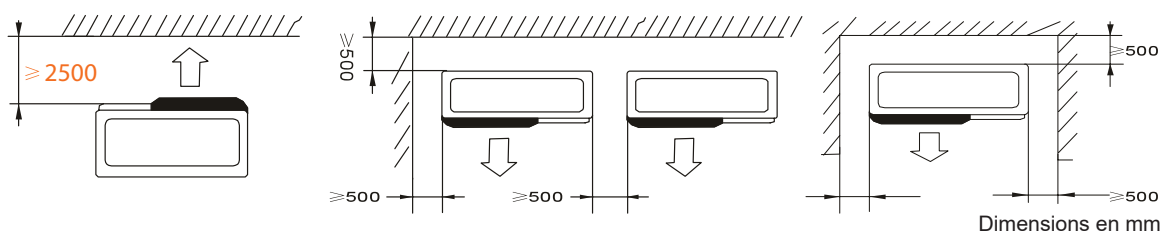

Place nothing less than one metre in front of the heat pump.
Leave 50 cm of empty space around the sides and rear of the heat pump.

Do not leave any obstacle above or in front of the unit!

3. Installation

3.3 Installation layout

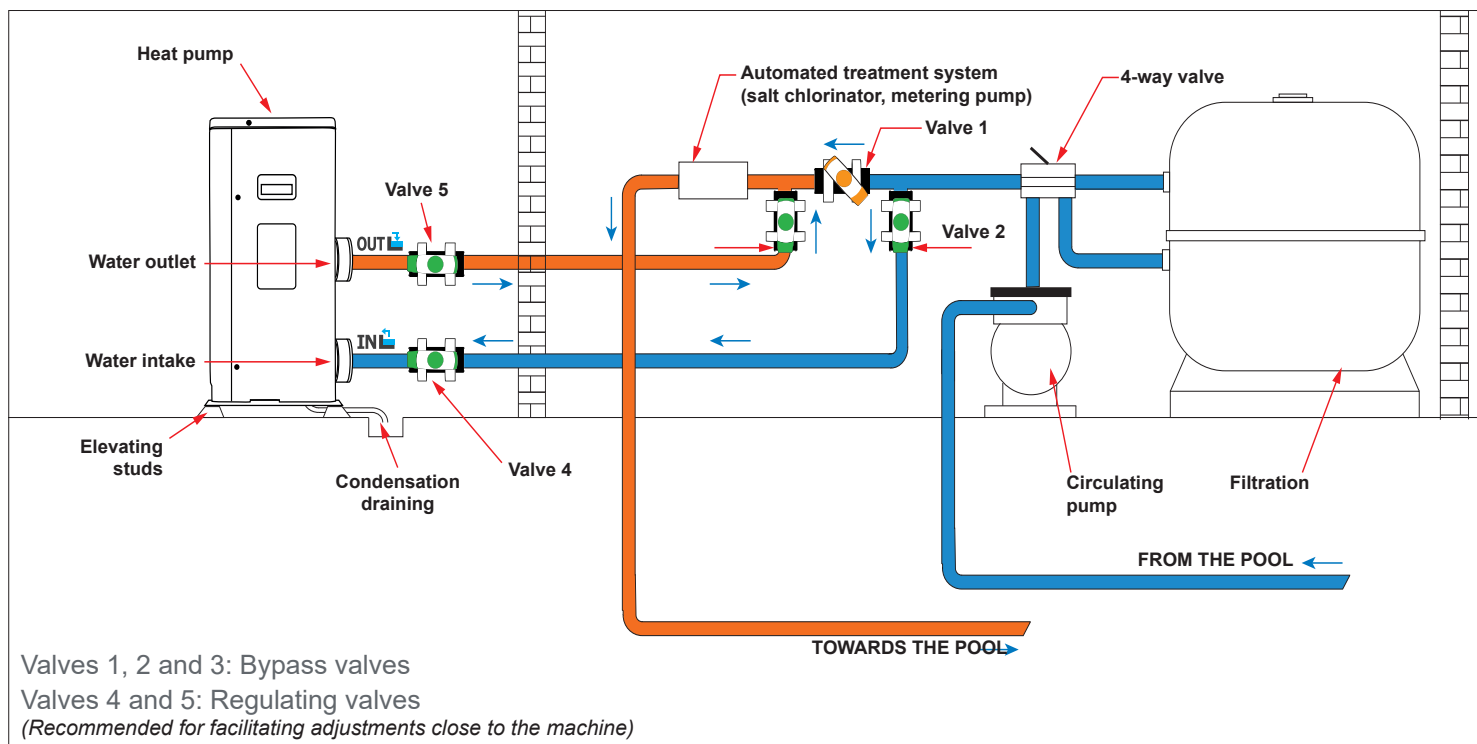

Key



Half-open valve



Open valve

3.4 Connecting the condensation draining kit

While operating, the heat pump is subject to condensation. This will result in a more or less large run-off of water, depending on the degree of humidity. To channel this flow, we recommend that you install the condensation drainage kit.

How do you install the condensation drainage kit?

Install the heat pump, raising it at least 10 cm with solid water-resistant pads, then connect the drainage pipe to the opening located under the pump.

3.5 Installing the unit on noise-damping supports

In order to minimise the noise pollution associated with heat pump vibrations, it can be positioned on vibration absorbing pads.

To do this, you simply have to position a pad between each of the unit's feet and its support, and then fix the heat pump to the support with suitable screws.

3. Installation



WARNING: Installation must be carried out by a qualified engineer.

This section is provided for information purposes only and must be checked and adapted if necessary according to the actual installation conditions.

3.6 Hydraulic connection

By-Pass assembly

The heat pump must be connected to the pool by means of a By-Pass assembly.

A By-Pass is an assembly consisting of 3 valves that regulate the flow circulating in the heat pump. During maintenance operations, the By-Pass permits the heat pump to be isolated from the system without interrupting your installation.

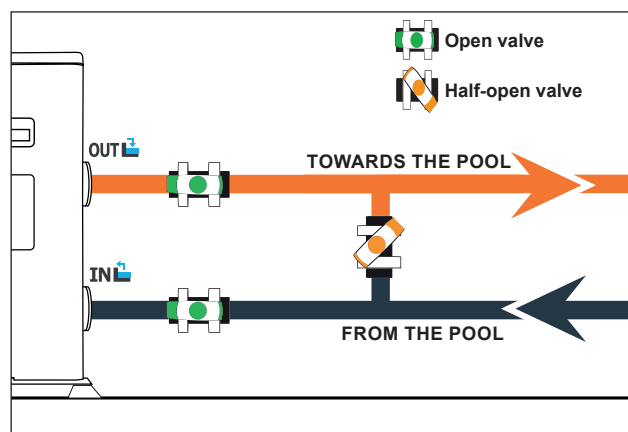

Making a hydraulic connection with the By-Pass kit



WARNING: Do not run water through the hydraulic circuit for 2 hours after applying the adhesive.

Step 1: Take the necessary steps to cut your pipes.

Step 2: Make a straight perpendicular cut through the PVC pipes with a saw.

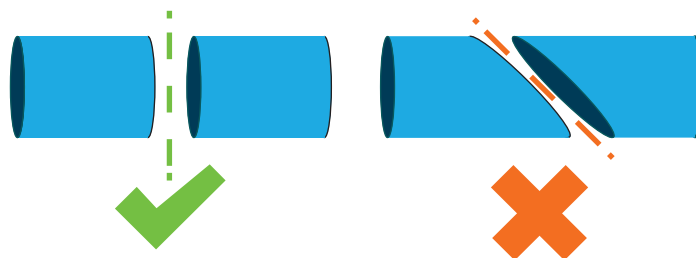

Step 3: Assemble your hydraulic circuit without connecting it in order to check that it perfectly fits your installation, then dismantle the pipes to be connected.

Step 4: Chamfer the ends of the cut pipes with sandpaper.

Step 5: Apply stripper to the ends of the pipes to be connected.

Step 6: Apply the adhesive in the same place.

Step 7: Assemble the pipes.

Step 7: Clean off any adhesive remaining on the PVC.

Step 8: Leave to dry for at least 2 hours before putting the hydraulic circuit into water.

3. Installation

By-Pass assembly for one heat pump

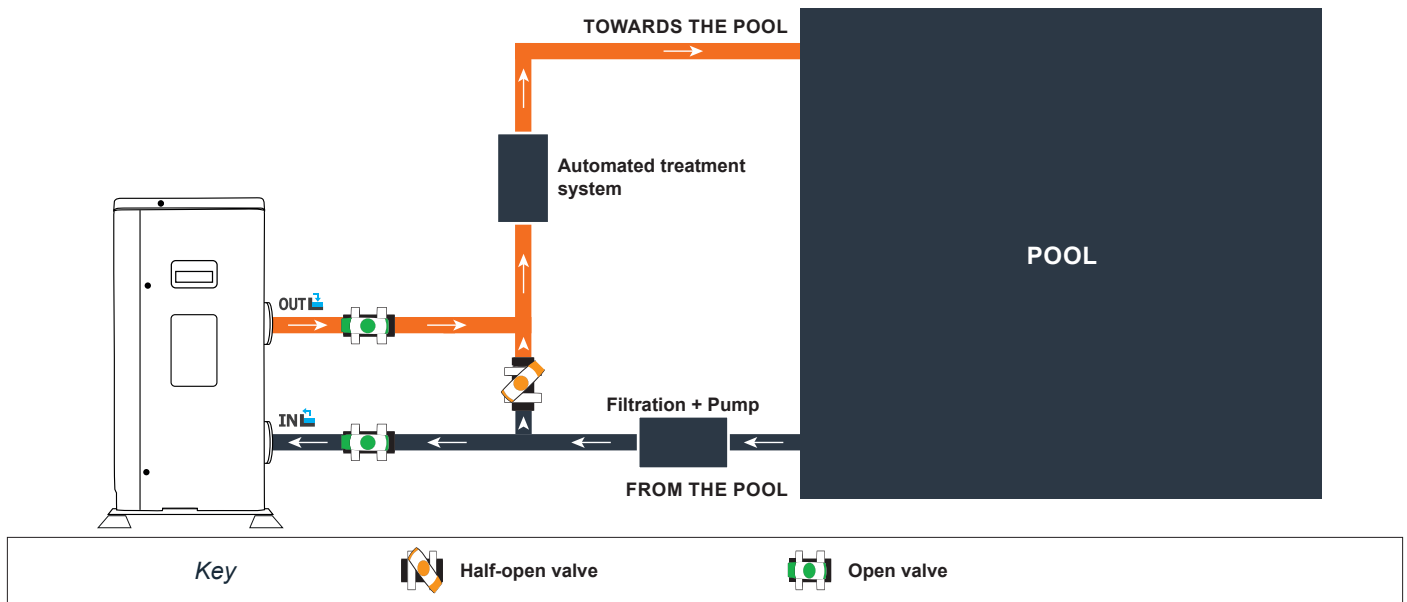

By-Pass assembly for more than one heat pump

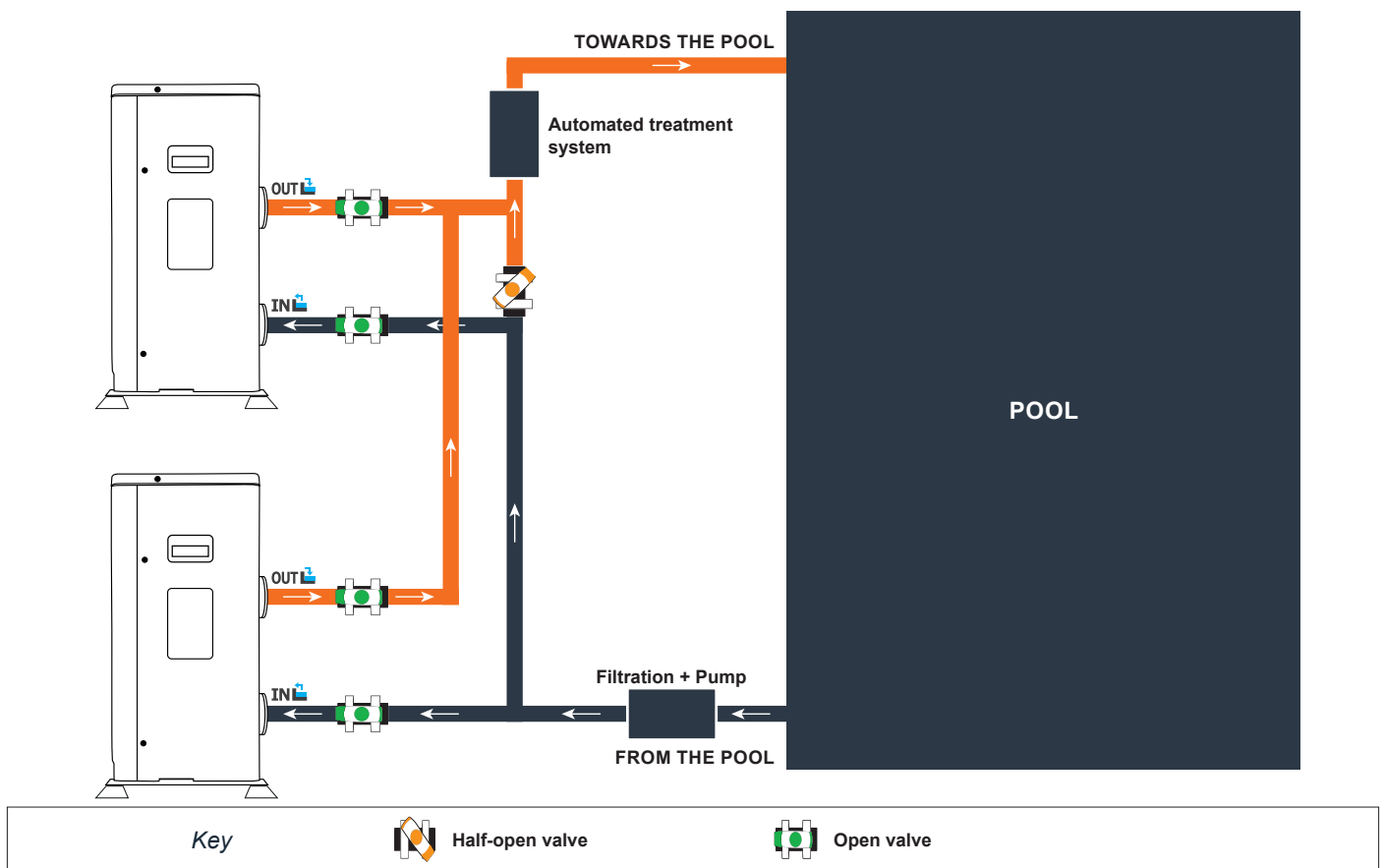

The filter located upstream of the heat pump must be regularly cleared so that the water in the system is clean, thus avoiding the operational problems associated with dirt or clogging in the filter.

3. Installation



WARNING: Installation must be carried out by a qualified engineer.

This section is provided for information purposes only and must be checked and adapted if necessary according to the actual installation conditions.

3.7 Electrical installation

To function safely and maintain the integrity of your electrical system, the unit must be connected to a general electricity supply in accordance with the following regulations:

Upstream, the general electricity supply must be protected by a 30 mA differential switch.

The heat pump must be connected to a suitable D-curve circuit breaker (see table below) in accordance with current standards and regulations in the country where the system is installed.

The electricity supply cable must be adapted to match the unit's rated power and the length of wiring required by the installation (see table below). The cable must be suitable for outdoor use.

For a three-phase system, it is essential to connect the phases in the correct sequence. If the phases are inverted, the heat pump's compressor will not work.

In places open to the public, it is mandatory to install an emergency stop button close to the heat pump.

Models	Electricity supply	Max. current	Cable diameter	Protection Thermal-magnetic (D curve) protection
Vega Pac Fi 50	1-phase 220-240V/1N~50Hz	8	RO2V 3x2.5 mm ²	16 A
Vega Pac Fi 70		10	RO2V 3x2.5 mm ²	16 A
Vega Pac Fi 90		13	RO2V 3x2.5 mm ²	16 A

¹ Cable cross-section suitable for max. length 10 metres. For longer than 10 metres, consult an electrician.

3. Installation

3.8 Electrical connection



WARNING: The heat pump's power supply MUST be disconnected before any operation.

***VP** Please comply with the following instructions to electrically connect the heat pump.*

Step 1: Detach the electrical side panel with a screwdriver to access the electrical terminal block.

Step 2: Insert the cable into the heat pump unit by passing it through the opening provided for that purpose.

Step 3: Connect the power supply cable to the terminal block in accordance with the diagram below.

Step 4: Carefully close the heat pump panel.

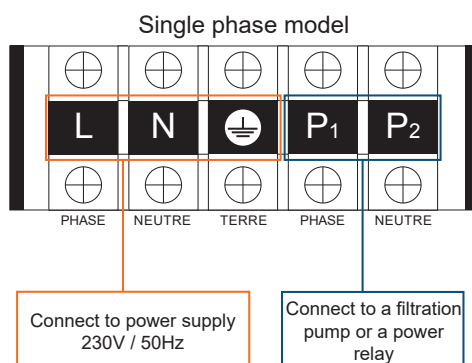

Servo-control of circulating pump

Depending on the type of installation, you can also connect a circulating pump to terminals P₁ and P₂ so that this operates in tandem with the heat pump.



WARNING: Servo-control of a pump whose power exceeds 5A (1000W) requires the use of a power relay.

4. Use

4.1 Wired remote control

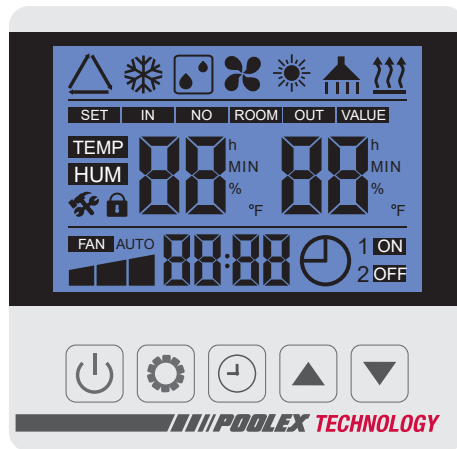



















4.2 Control box displays



Before starting, ensure that the filtration pump is working and that water is circulating through the heat pump.

Prior to setting your required temperature, you must first select an operating mode for your heat pump:

	+nE Cooling mode Full Inverter		Speed compressor
	+nE Heating Mode Full Inverter		Fan speed
	Automatic mode Full Inverter		inlet water temperature
	+H ! Heating Mode boost		Parameters menu
	+H ! Cooling boost		Temperature unit
	+L □ Heating Mode Eco Silence		Clock
	+L □ Cooling Eco Silence		Clock programming
	Defrost		Keypad lock
	Temperature setting		Programming On Off
	Setpoint and water inlet temperature		

4. Use

4.3 Operating mode selector

Push on  to change the operating mode. The different modes appear in the following order:

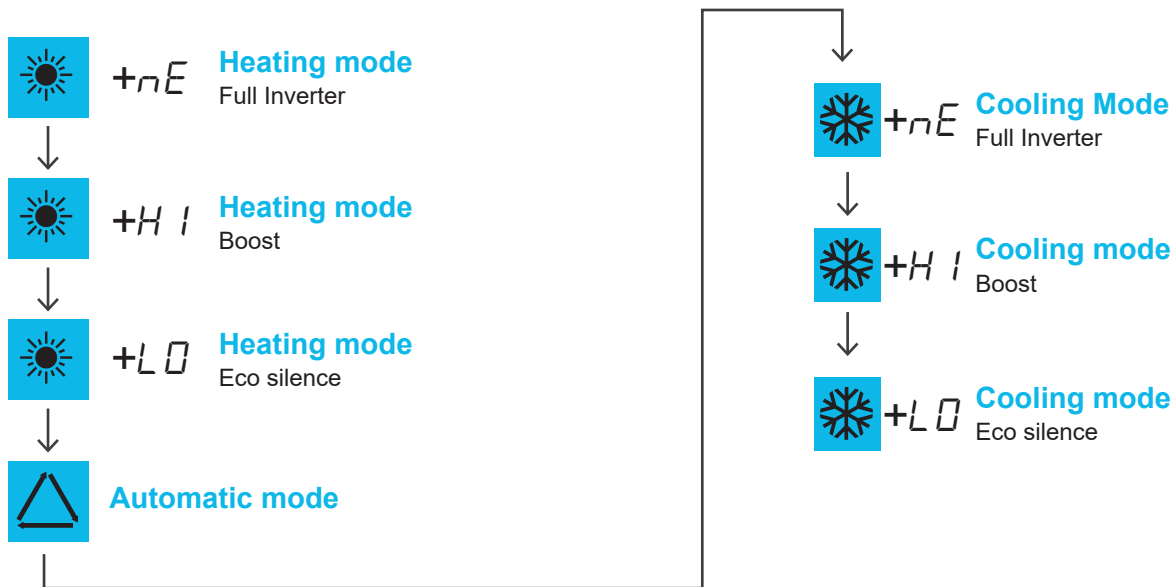



4.4 Temperature setting

Once the control panel is unlocked, press to  and  to set and modify the value, press SET to confirm the value.

Press to  to confirm the parameters.

4.5 Parameter checking and setting

Step 1 : To enter the verification parameters, Keep pressing  press for 3 seconds, then scroll through the parameters with the buttons  and .

Parameters checking in annex.

WARNING:





When the cooling mode switches to heating mode or vice-versa, the heat pump will restart after 10 minutes.

When the incoming water temperature is less than or equal to the required temperature (setpoint temperature - 1°C), the heat pump will switch to heating mode. The compressor will stop when the temperature of the incoming water is greater than or equal to the required temperature (setpoint temperature + 1°C).

4. Use

4.6 Setting the clock

Step 1 : press 5s to  to enter current time setting.

Step 2 : Press to , the hours are blinking, push to  and  to adjust the hours.

Step 3 : Press to , the minutes are blinking, push to  and  to adjust the minutes.

Step 4 : Press to  to validate and return to the main screen.

Step 1

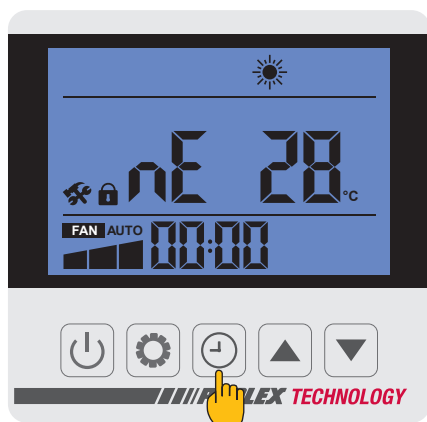

Step 2

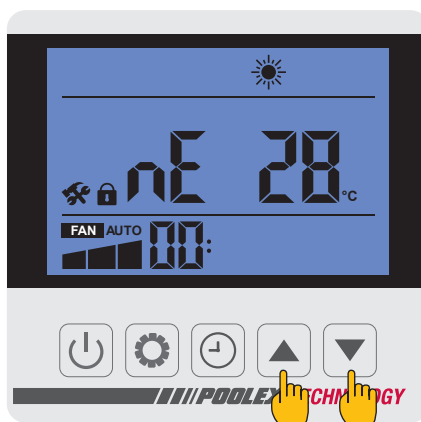

Step 3

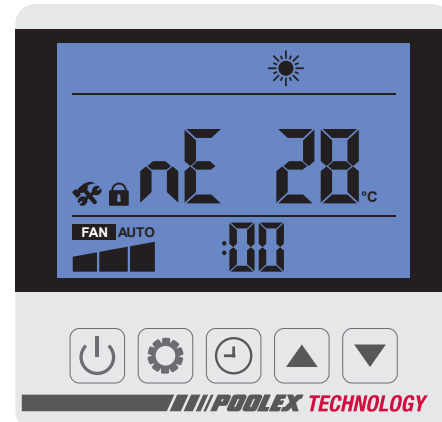

Step 3

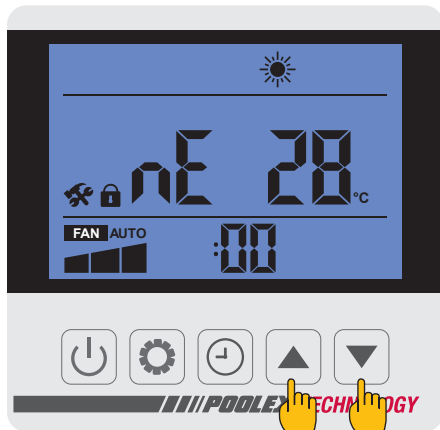

Step 4

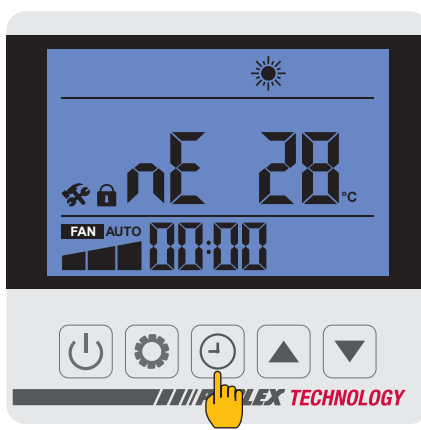

Bon à savoir



WARNING: When the cooling mode switches to heating mode or vice-versa, the heat pump will restart after 10 minutes.



When the incoming water temperature is higher or equal to the required temperature (setpoint temperature + 1°C), the heat pump will switch to cooling mode. The compressor will stop when the temperature of the incoming water is less than or equal to the required temperature (setpoint temperature - 1°C).



4. Use

4.7 Programming Start/Stop

This function is for programming the Start/Stop timing. You can programme up to 2 different Start/Stop timings. Setting is as follows:



Step 1 : Push to  to enter into timer functions.

Step 2 : Timer 1 blinking, press  to enter timer ON 1 hour setting, press  and  to modify the value of starting hours.

Step 3 : press  key again, minute are blinking, then press  and  to modify the value of starting minutes.

Step 4 : Press  again to modify timer OFF, same way as upon.

Step 5 : Press  again to confirm Timer ON / OFF.

Step 6 : Press  and  to set timer ON OFF 2 setting.

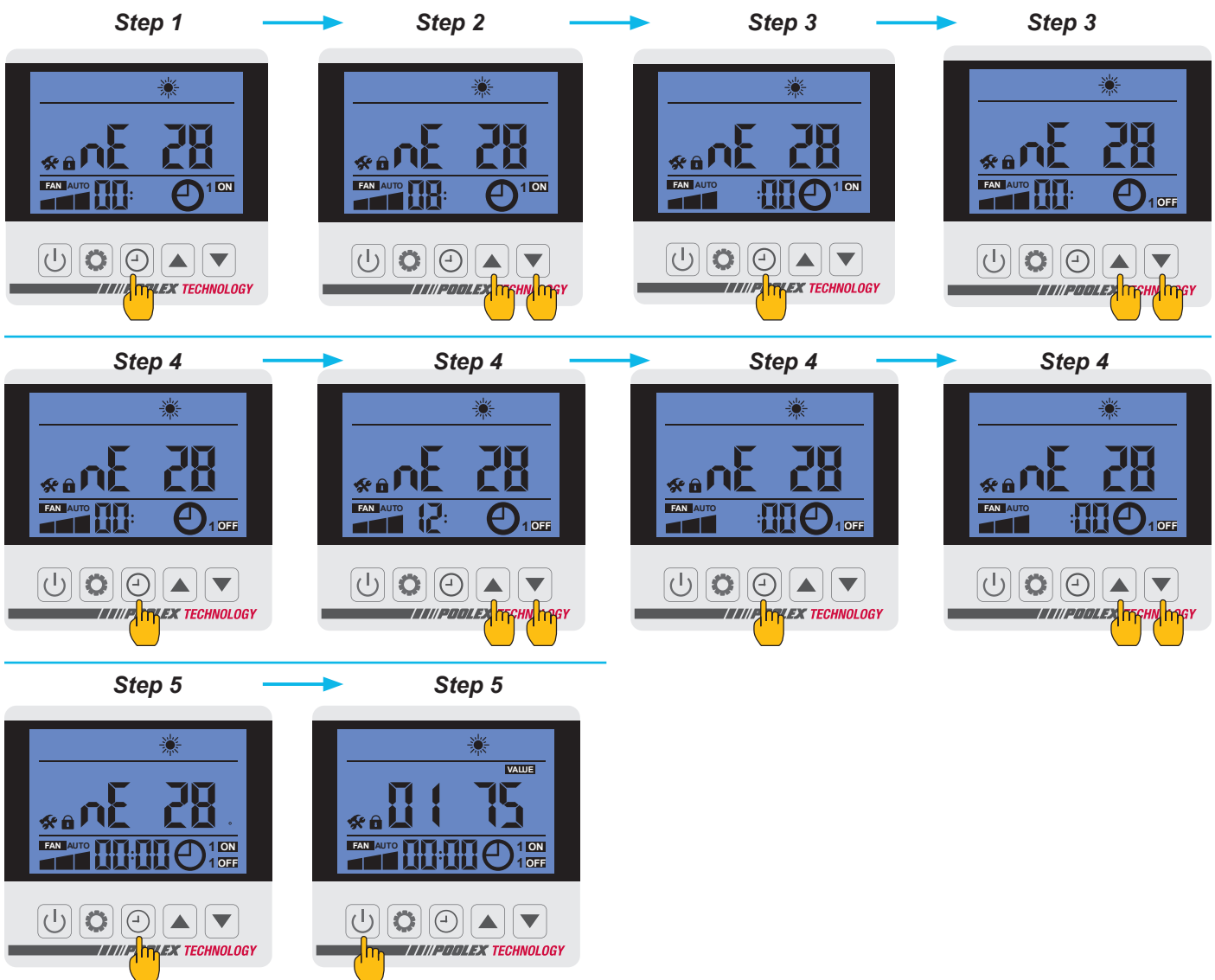

4.8 Key lock and unlock

To unlock the control panel, press the  button for 5 seconds

If no action has been taken on the control unit for 60 seconds, the control panel will lock.

4. Use

4.9 System parameter query



WARNING : This operation is used to assist servicing and future repairs.
The default settings should only be modified by an experienced professional person.



WARNING : Any change to the reserved settings will automatically void the warranty.

The status values can be checked via the remote control by following these steps

Step 1 : Keep pressing 3 s until you enter the settings.

Step 2 : Press and to check the status values.

Step 3 : Press to return to the main screen.

Step 1

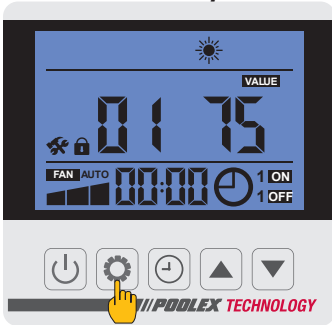

Status values table in annex

Step 2

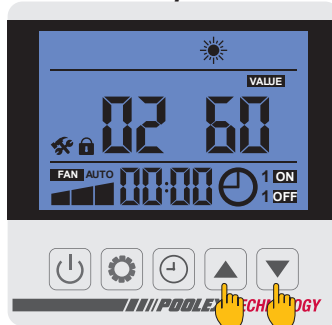

Step 3

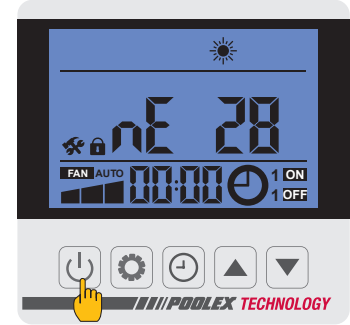

4.10 Manufacturer parameter query



WARNING : This operation is used to assist servicing and future repairs.
The default settings should only be modified by an experienced professional person.



WARNING : Any change to the reserved settings will automatically void the warranty.

The status values can be checked via the remote control by following these steps

Step 1 : Keep pressing + 3 s until you enter the settings, then enter the password 1688.

Step 2 : Press and to check the status values.

Step 3 : Press to return to the main screen.

Step 1

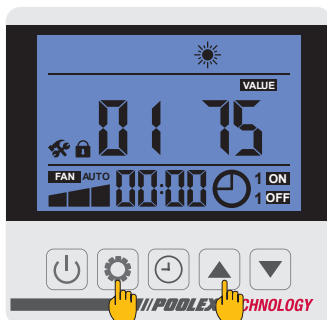

Status values table in annex

Step 2

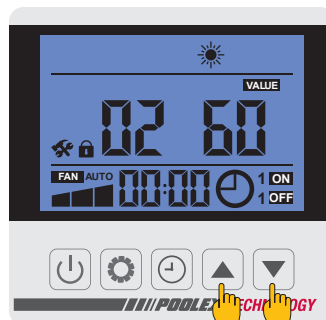

Step 3

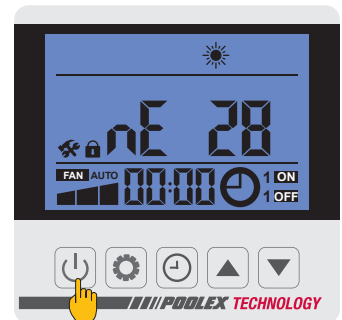

4. Use

4.11 WiFi

4.11.1. Downloading & Installing the «Smart Life» app

About the Smart Life app:

You'll need to create a «Smart Life» account to control your heat pump remotely.

The «Smart Life» app lets you control your home appliances from anywhere. You can add and control multiple devices at once.

- Also compatible with Amazon Echo and Google Home (depending on the country).
- You can share your devices with other Smart Life accounts.
- Receive real-time operational alerts.
- Create scenarios with several devices, depending on the app's weather data (geolocation required).

For more information, go to the «Help» section of the «Smart Life» app

The «Smart Life» app and services are provided by Hangzhou Tuya Technology. Poolstar, owner and distributor of the Poollex brand, cannot be held responsible for the operation of the «Smart Life» app. Poolstar has no visibility on your «Smart Life» account.

iOS :

Search for «Smart Life» in the App Store to download the app:

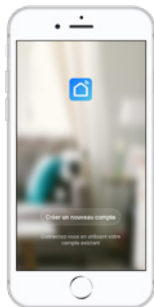

Check the compatibility of your phone and the version of your OS before installing the application

Android :

Search for «Smart Life» on Google Play to download the app :

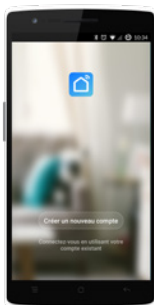

Check the compatibility of your phone and the version of your OS before installing the application

4. Use

4.11.2. Setting up the app

WARNING : Before you begin, make sure you have downloaded the «Smart Life» app, connected to your local WiFi network, and that your heat pump is electrically powered and running.

You'll need to create a «Smart Life» account to control your heat pump remotely. If you already have a Smart Life account, please log in and go directly to step 3.

Step 1 : Click on «Create new account» and choose to register by «Email» or «Phone,» where a verification code will be sent to you.

Enter your email address or phone number and click «Send verification code».

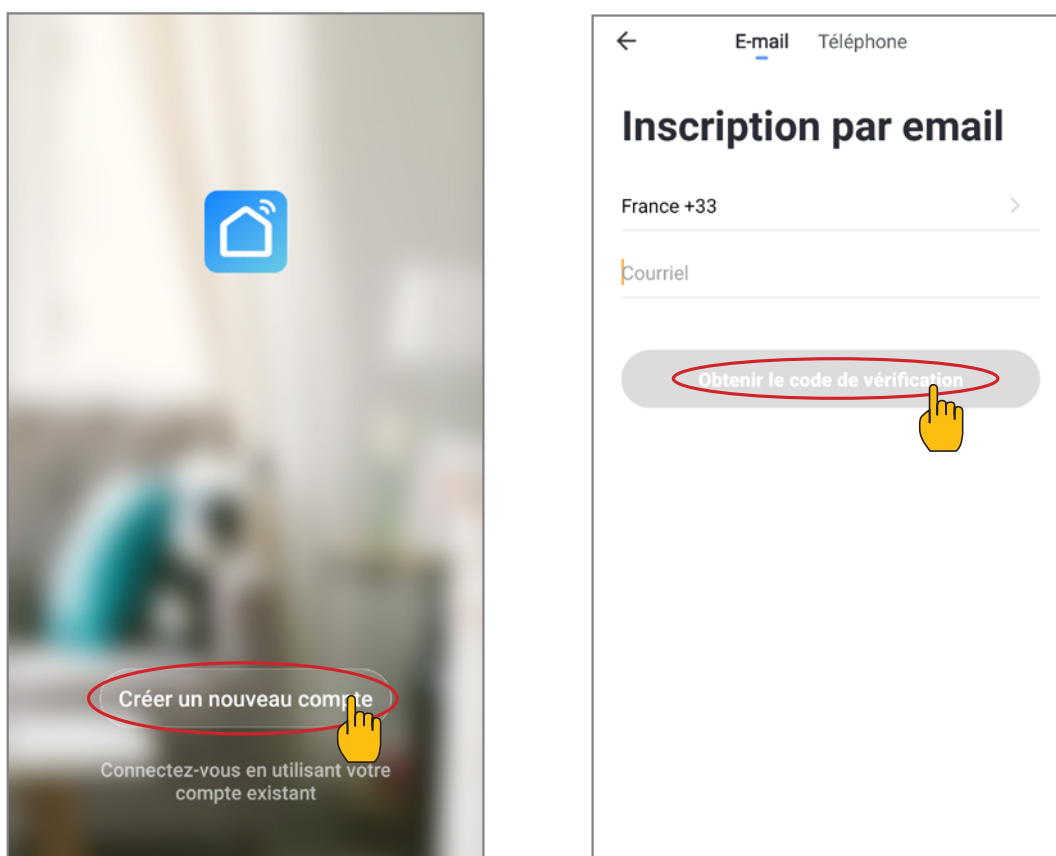

Step 2 : Enter the verification code received by email or phone to validate your account.

Congratulations! You are now part of the «Smart Life» community.

4. Use

Step 3 (Recommended): Add an object by clicking «...» and then «Add Object.» Enter its name («Pool» for example), then click «Done.»

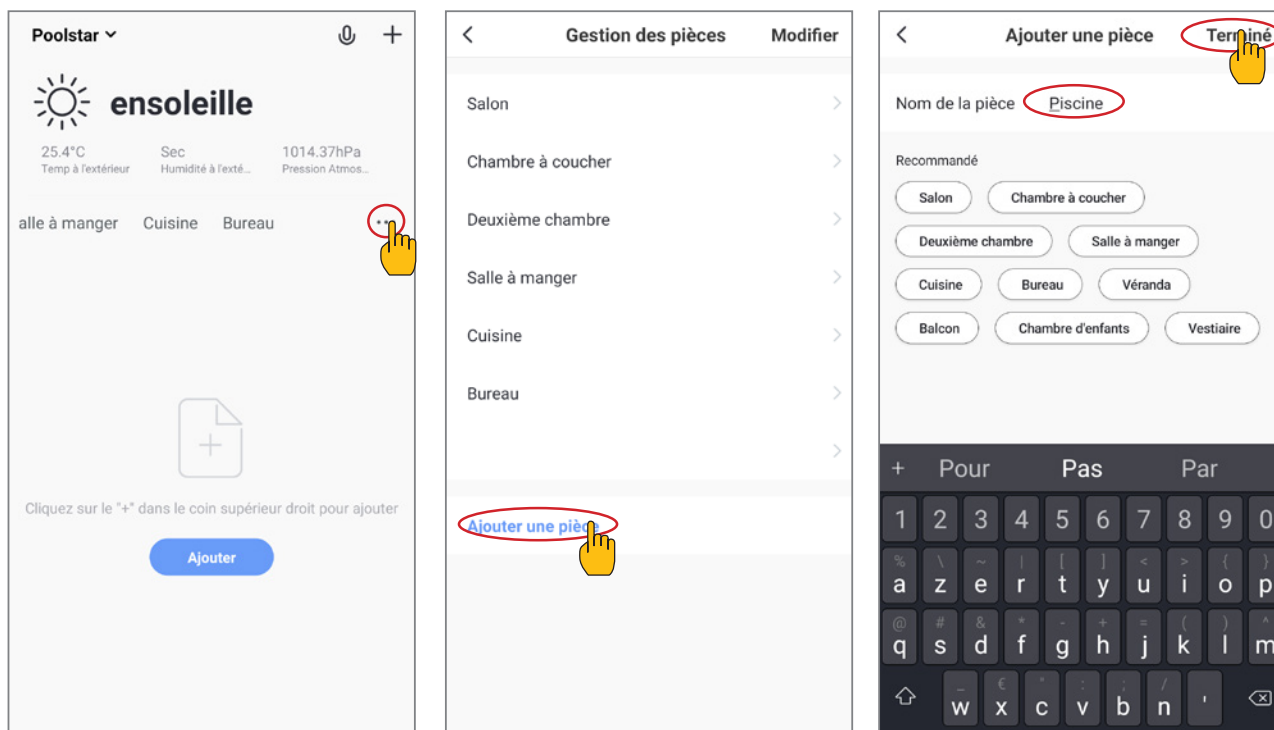

Step 4 : Now add a device to your «Pool»

Click «Add» or «+» and then «Large appliances...» followed by «Water heater.»

At this point, leave your smartphone on the «Add» screen and go to the pairing step for your control box.

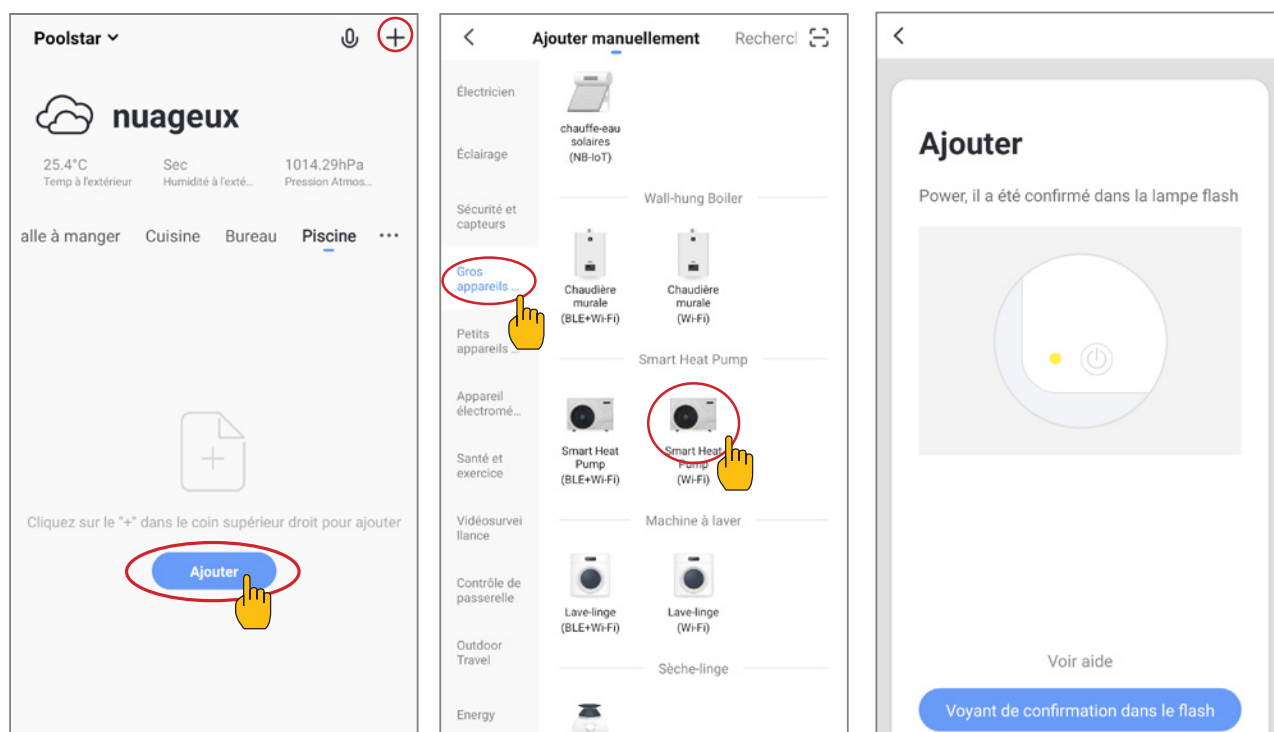

4. Use

4.11.3 Pairing the heat pump

4.11.3.1 EZ Mode

Step 1 : Now start the pairing.

Choose your home WiFi network, enter the WiFi password and press «Confirm».

Step 2 : Activate the pairing mode on your heat pump according to the following procedure:

The procedure depends on the model of your control box:

EZ Mode (default) :

Push + (or) simultaneously for 5s, flashes quickly, the control unit is ready to be paired.

AP mode :

Push + (or) simultaneously for 5s, flashes quickly, the control unit is ready to be paired.



CAUTION The «Smart Life» application only supports 2.4GHz WiFi networks.

If your WiFi network uses the 5GHz frequency, go to the interface of your home WiFi network to create a second 2.4GHz WiFi network (available for most Internet boxes, routers and WiFi access points).

The pairing is successful, you can rename your Poolex heat pump then press «Done».
Congratulations, your heat pump can now be controlled from your smartphone.

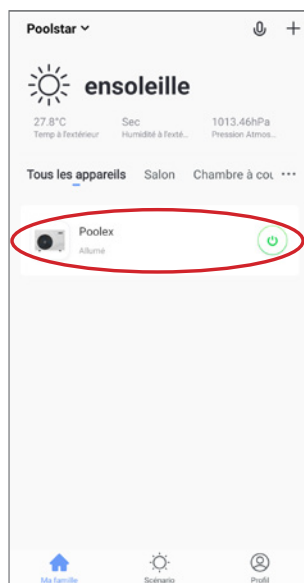
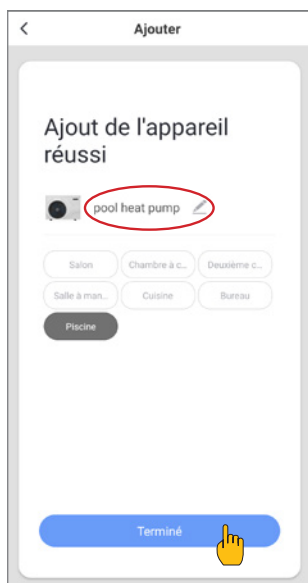

Note: The flashing stops when the box is connected to WiFi

4. Use

4.11.4. Controlling

Interface

- 1 Current pool temperature
- 2 Temperature setpoint
- 3 Current operating mode
- 4 Switch the heat pump on/off
- 5 Change the temperature
- 6 Change the operating mode
- 7 Set the operating range



Configure the operating ranges for the heat pump

Step 1 : Create a schedule, choose the time, day(s) of the week(s), and the action (turn on or off) and save.

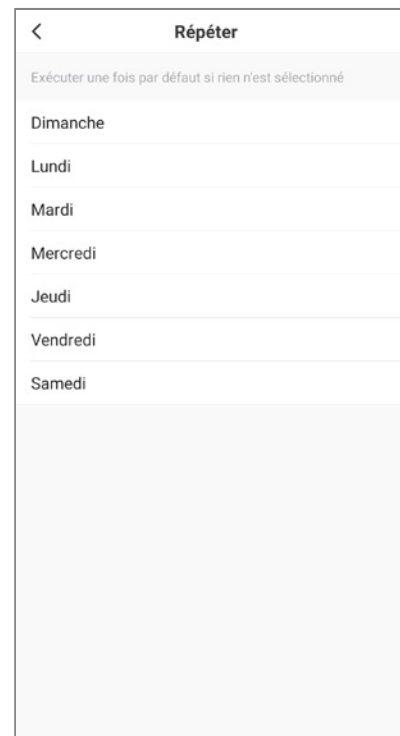
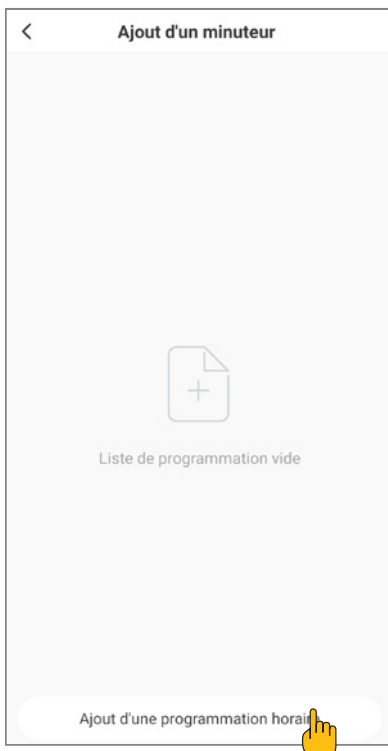

Step 2 : To delete a time slot, press on it and hold.

5. Operation

5.1 Operation

Conditions of use

For the heat pump to operate normally, the ambient air temperature must be between -7°C and 43°C.

Recommendations prior to start-up

Before activating the heat pump, please:

- ✓ Check that the unit is firmly secured and stable.
- ✓ Check that the gauge indicates a pressure greater than 80 psi.
- ✓ Check that the electrical wiring is properly connected to the terminals.
- ✓ Check the earthing.
- ✓ Check that the hydraulic connections are tight and that there is no leakage of water.
- ✓ Check that the water is circulating correctly in the heat pump and that the flow rate is adequate.
- ✓ Remove any unnecessary object or tool from around the unit.

Operation

1. Activate the unit's power supply protection (differential switch and circuit-breaker).
2. Activate the circulating pump if it is not servo-controlled.
3. Check the By-Pass opening and the control valves.
4. Activate the heat pump by pressing once on 
5. Adjust the remote control clock.
6. Select the required temperature by using one of the remote control's mode.
7. The heat pump's compressor will start up after a few moments.

All you have to do now is wait until the required temperature is reached.



WARNING: Under normal conditions, a suitable heat pump can heat the water in a swimming pool by 1°C to 2°C per day. It is therefore quite normal to not feel any temperature difference in the system when the heat pump is working.
A heated pool must be covered to avoid any loss of heat.

5.2 Servo-control of circulating pump

If you have connected a circulating pump to terminals P1 and P2, it is automatically electrically powered when the heat pump operates.

5. Operation

5.3 Using the pressure gauge

The gauge is for monitoring the pressure of the refrigerant contained in the heat pump. The values it indicates can vary considerably, depending on the climate, temperature and atmospheric pressure.

When the heat pump is in operation:

The gauge's needle indicates the refrigerant pressure.

Mean operating range between 250 and 400 PSI, depending on the ambient temperature and atmospheric pressure.

When the heat pump is shut down:

The needle indicates the same value as the ambient temperature (within a few degrees) and the corresponding atmospheric pressure (between 150 and 350 PSI maximum).

If left unused for a long period of time :

Check the pressure gauge before starting up the heat pump. It must indicate at least 80 PSI.

If the pressure goes down too much, the heat pump will display an error message and automatically go into 'safe' mode.

This means that there has been a leakage of refrigerant and that you must call a qualified technician to replace it.

5.4 Antifreeze protection



WARNING: For the antifreeze system to work, the heat pump must be powered and the circulating pump activated. If the circulating pump is servo-controlled by the heat pump, it will be automatically activated.

When the heat pump is on standby, the system monitors the ambient temperature and the water temperature in order to activate the antifreeze programme if required.

The antifreeze programme is automatically activated when the ambient temperature or the temperature of the water is less than 2°C and when the heat pump has been shut down for more than 120 minutes.

When the antifreeze programme is running, the heat pump activates its compressor and the circulating pump so as to reheat the water until the water temperature exceeds 2°C.

The heat pump automatically leaves the antifreeze mode when the ambient temperature is greater than or equal to 2°C or when the heat pump is activated by the user.

6. Maintenance and servicing

6.1 Maintenance and servicing



WARNING: Before undertaking maintenance work on the unit, ensure that you have disconnected the electrical power supply.

Cleaning

The heat pump's casing must be cleaned with a damp cloth. The use of detergents or other household products could damage the surface of the casing and affect its properties.

The evaporator at the rear of the heat pump must be carefully cleaned with a vacuum cleaner and soft brush attachment.

Annual maintenance

The following operations must be undertaken by a qualified person at least once a year.

- ✓ Carry out safety checks.
- ✓ Check the integrity of the electrical wiring.
- ✓ Check the earthing connections.
- ✓ Monitor the state of the pressure gauge and the presence of refrigerant.

6.2 Winter storage

In the winter months when the ambient temperature is lower than 3°C, a shut-down heat pump must be winterised to avoid any frost damage.

Winterising in 4 steps



Step 1
Disconnect the heat pump from the power supply.

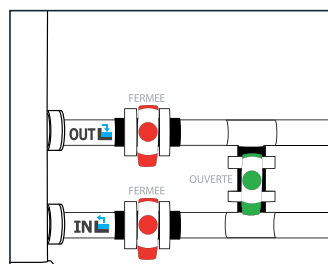

Step 2
Open the By-Pass valve. Close the inlet and outlet valves.

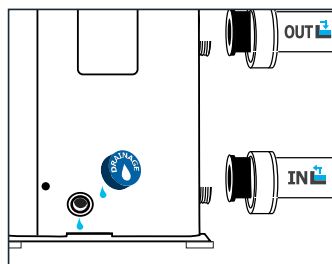

Step 3
Unscrew the water pipes in order to drain any water from the heat pump.

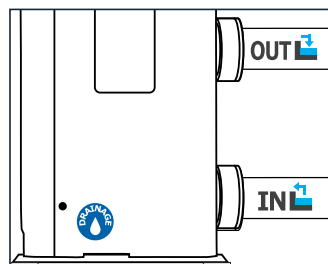

Step 4
Screw back the drain plug and pipes or block them with rags so as to prevent any foreign bodies from getting into the circuit. Finally, protect the pump with its winter storage cover.



If a circulating pump is servo-controlled by the heat pump, drain this also.

7. Repairs



WARNING: Under normal conditions, a suitable heat pump can heat the water in a swimming pool by 1°C to 2°C per day. It is therefore quite normal to not feel any temperature difference in the system when the heat pump is working.
A heated pool must be covered to avoid any loss of heat.

7.1 Breakdowns and faults

In the event of a problem, the heat pump's screen displays a fault symbol E_r instead of temperature indications. Please consult the table opposite to find the possible causes of a fault and the actions to be taken.

Fault code examples:

Fault code 03

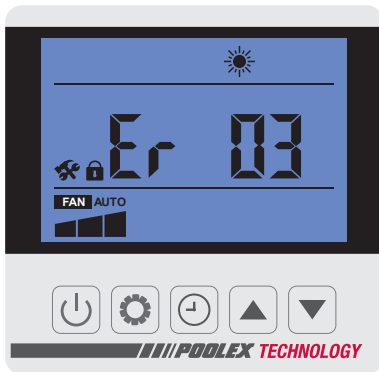

Fault code 04

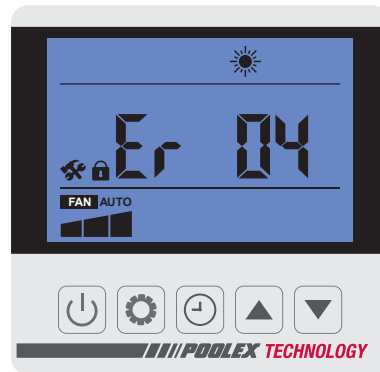

Fault code 21

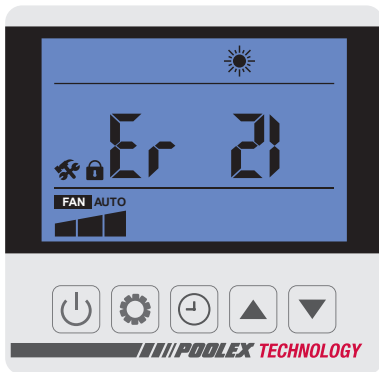

Fault code 32

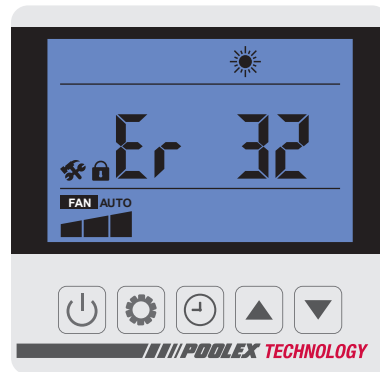

7. Repairs

7.2 List of faults

Code	Fault	Possible causes	Action
03	Flow sensor malfunction	Insufficient water in heat exchanger	Check your water circuit operation and the opening of the By-Pass valves
		Sensor disconnected or defective	Reconnect or replace sensor
04	Antifreeze protection	Protection activated when the ambient temperature is too low and the unit is on standby	No intervention is necessary
05	High pressure protection	Insufficient water flow	Check water pump operation and openings of By-Pass inlet/outlet valves
		Excess refrigerant gas	Readjust the refrigerant volume
		Defective 4-way valve	Replace the 4-way valve
		High pressure switch disconnected or defective	Reconnect or replace high pressure switch
06	Low pressure protection	Insufficient refrigerant gas	Readjust the refrigerant volume
		Defective 4-way valve	Replace valve
		Low pressure switch disconnected or defective	Reconnect or replace low pressure switch
09	Connection problem between PCB and wired remote control	Bad connection	Check wiring connections between remote control and PCB
		Defective wired remote control	Replace remote control
		Defective PCB	Replace PCB
10	Connection problem between PCB and inverter module	Bad connection	Check wiring connections between PCB and inverter module
		Defective inverter module	Replace inverter module
		Defective PCB	Replace PCB
12	Vented air temperature too high	Insufficient refrigerant gas	Readjust the refrigerant volume
15	Water intake temperature sensor malfunction	Sensor disconnected or defective	Reconnect or replace sensor
16	Outside coil temperature error	Sensor disconnected or defective	Reconnect or replace sensor
18	Vented temperature error	Sensor disconnected or defective	Reconnect or replace sensor
20	Inverter module protection	Defective inverter module	Power off the heat pump and restart
			Replace inverter module
		Compressor is defective	Replace the compressor
21	Ambient temperature error	Sensor disconnected or defective	Reconnect or replace sensor
23	Water temperature at outlet too low for cooling mode	Insufficient water flow	Check water pump operation and openings of By-Pass inlet/outlet valves
27	Water outlet error	Sensor disconnected or defective	Reconnect or replace sensor
29	Backed temperature error	Sensor disconnected or defective	Reconnect or replace sensor
32	Outlet temperature too high for heating mode protection	Insufficient water flow	Vérifiez la bonne circulation de l'eau dans la pompe à chaleur, et l'ouverture des vannes entrée/sortie du By Pass
35	Compressor current protection	The speed of compressor is too high	Compressor will be lower the speed auto
		Water temperature is too high	Check water pump operation and openings of By-Pass inlet/outlet valves
		Ambient temperature is too high, air volume is too little	Check the fan is working properly and the air inlet is unobstructed
42	Inside coil temperature error	Sensor disconnected or defective	Reconnect or replace sensor

7.3 Errors

Code	Anomalies	Causes possibles	Actions
1	IPM excessive current	IPM module failure	Replace the inverter module
2	Compressor failure	Compressor failure	Replace the compressor
16	DC bus voltage too low	Input voltage too low/PFC module failure	Check input voltage/replace module
260	AC input voltage too high	Input three-phase unbalance	Check input the 3-phase voltage
264	AC input voltage too low	Input voltage too low	Check input voltage
288	IPM temp too high	Fan motor failure/Air duct blockage	Check fan motor/air duct

7. Repairs

7.4 Wiring diagrams

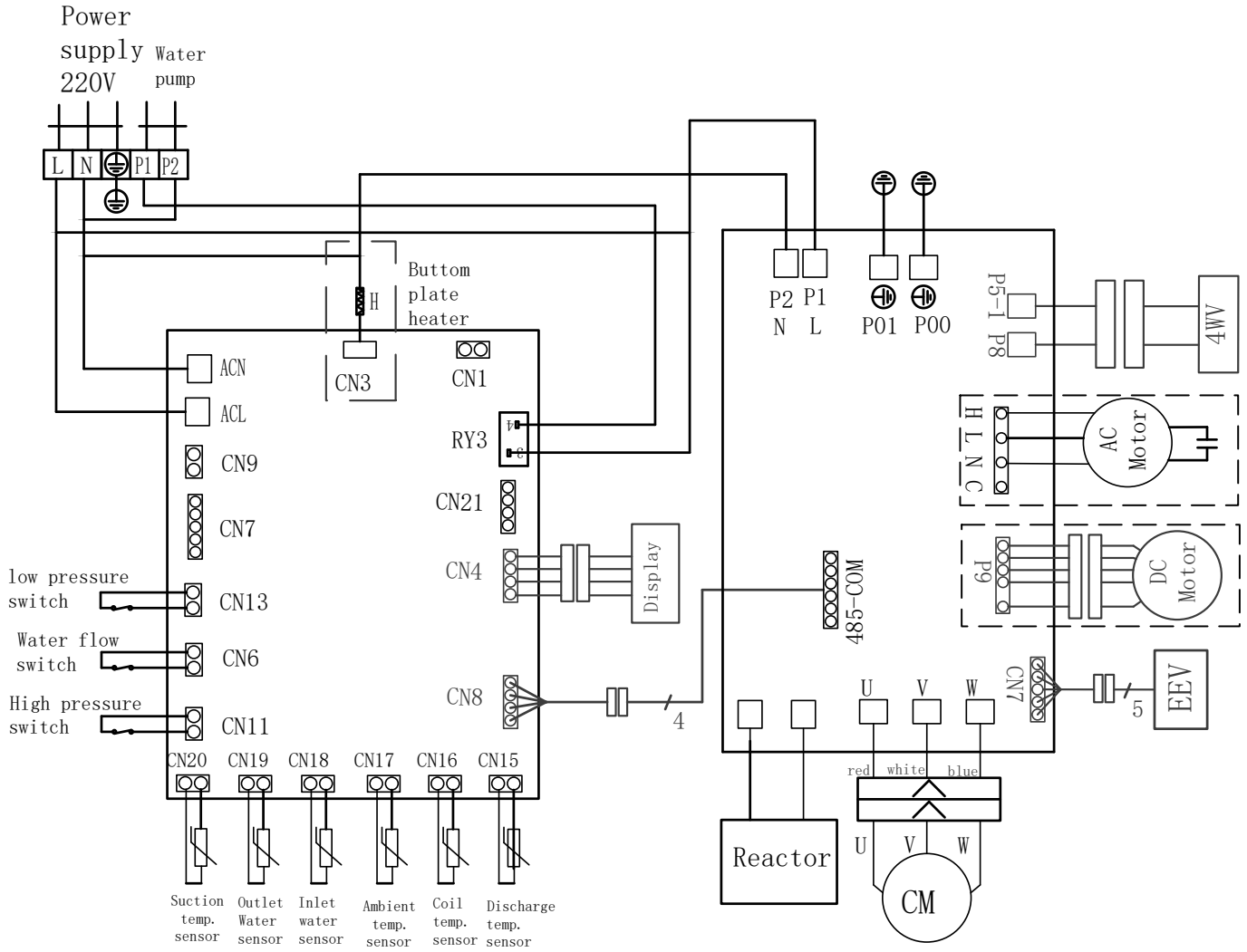

8. Recycling

8.1 Recycling the heat pump

Your heat pump has reached the end of its life and you wish to dispose of it or to replace it. Do not throw it in the rubbish bin.

A heat pump must be disposed of separately with a view to its reuse, recycling or upgrading. It contains substances that are potentially hazardous to the environment but which will be eliminated or neutralised by recycling.

YOU HAVE THREE SOLUTIONS:

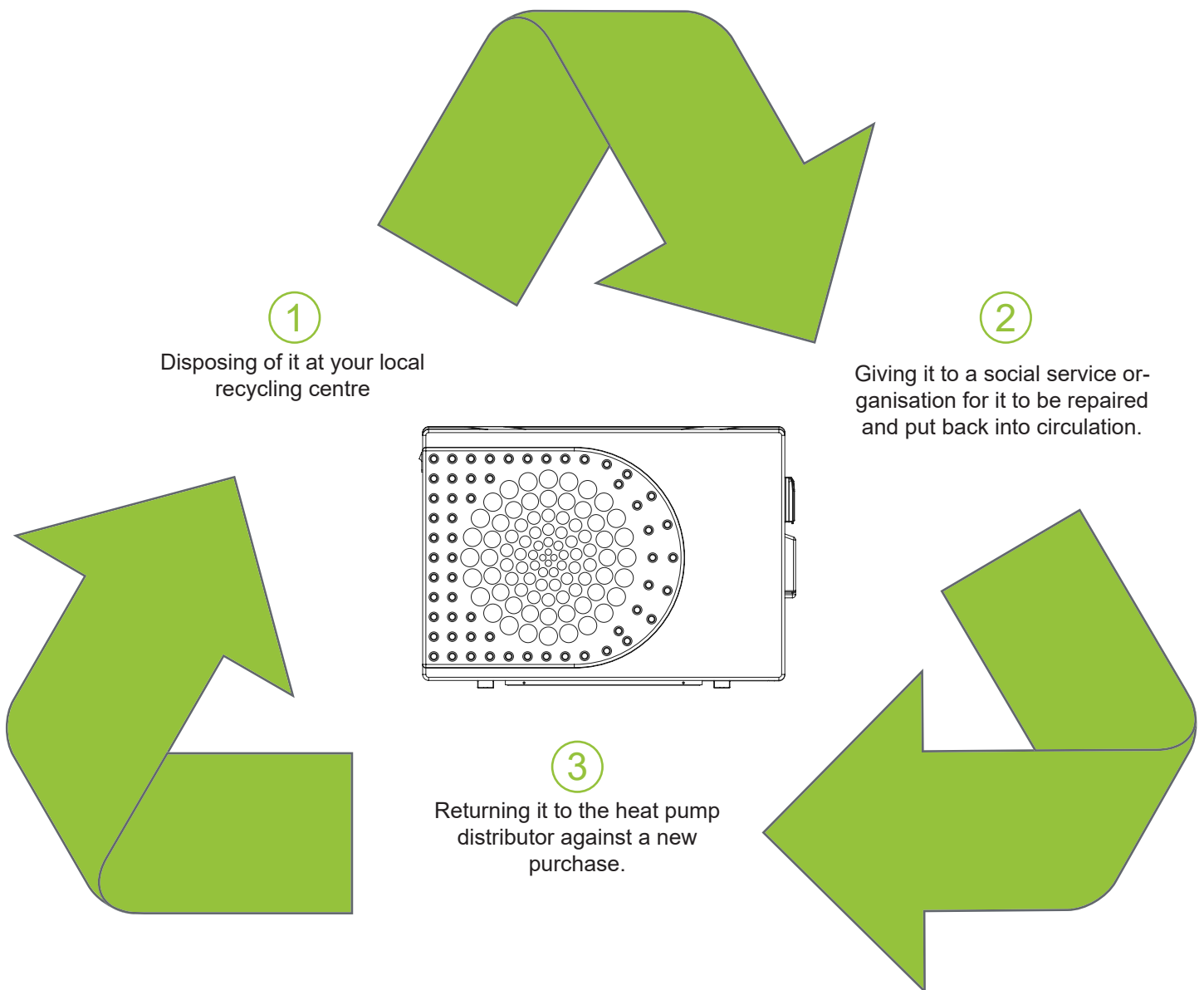

9. Warranty

9.1 General warranty conditions

The Poolstar Company guarantees the original owner against defective materials and faults in the manufacture of the Poolex Vega heat pump for a period of two (2) years.

The compressor is guaranteed for a period of Five (5) years.

The titanium tube heat exchanger is guaranteed for a period of fifteen (15) years against chemical corrosion, except for frost damage.

The condenser's other components are guaranteed for two (2) years.

The warranty becomes effective on the date of the first invoice.

The warranty does not apply in the following cases:



- Malfunction or damage arising from an installation, usage or repair that is not in compliance with the safety instructions.
- Malfunction or damage arising from a chemical agent that is unsuitable for the pool.
- Malfunction or damage arising from conditions that are unsuitable for the equipment's purposes of use.
- Damage arising from negligence, accident or force majeure.
- Malfunction or damage arising from the use of unauthorised accessories.

Repairs undertaken during the warranty period must be approved prior to being carried out by an authorised technician. The warranty shall be null and void if the repair to the equipment is carried out by a person who is not authorised by the Poolstar company.

The guaranteed parts shall be replaced or repaired at Poolstar's discretion. Defective parts must be returned to our workshops to be covered during the warranty period. The warranty does not cover labour costs or unauthorised replacements. The return of the defective part is not covered by the warranty.

10. Annex

10.1 Parameter checking

To enter the verification parameters, Keep pressing  press for 3 seconds, then scroll through the parameters with the buttons  and .

Code	Name	Note
T1	Air discharge temp.	
T2	Air suction temp.	
T3	Inlet water temp.	
T4	Outlet water temp.	
T5	Outdoor coil temp.	
T6	Outdoor ambient temp.	
T7	IPM temp.	
T8	Indoor coil temp.	
T9	Reserve	
T10	Reserve	
T11	Reserve	
Ft	Target frequency	
Fr	Current frequency	
1F	Main EEV opening	
2F	Auxiliary EEV opening	
od	Operation mode	1:cooling 4:heating
Pr	Fan speed	AC - 1:H 2:M 3:L DC - value*10
dF	Defrosting condition	
OIL	Oil return situation	
r1	Reserve	
r2	Bottom heater switch	
r3	Reserve	
STF	4 way valve switch	
HF	Reserve	
PF	Reserve	
PTF	Reserve	
Pu	Water pump switch	
AH	AC fan H speed switch	
Ad	AC fan M speed switch	
AL	AC fan L speed switch	
dcU	DC bus voltage	
dcC	Inverter compressor current(A)	
AcU	Input voltage	
AcC	Input current	
HE1	History error code	
HE2	History error code	
HE3	History error code	
HE4	History error code	
Pr	Protocol version	
Sr	Software version	

10. Annex



10.2 System parameter query

Keep pressing  3 s until you enter the settings.

Code	Name	Range	Default
L0	Water pump working mode	0: ON constantly 1: OFF 60s after compressor off,Pump ON 5 min Per L1 min.	1
L1	Water pump working period	In standby mode,water pump work 5 min per L1 min, L1=3~180	30
L2	Timer setting	0: Timer function OFF 1: Timer function ON	1
L3	Power OFF remember function	0=OFF 1=ON	1
L4	Background light setting	0: No background light 1:light ON constantly 2:light on if operating, light off if no operation	2
L5	Unit operation mode	Range : 0-3 0=Heating only 1=Cooling only 2=Heating&cooling 3=Cooling/heating/auto/quick heating/Silence heating mode/quick cooling/ silence cooling mode	3

10. Annex

10.3 Factory parameter query

Step 1 : Keep pressing  +  3 s until you enter the settings, then enter the password 1688.

N°	Description	Range	Default	Remarks
H0*	Accumulate heating operation time	30~120	45min	Adjustable
H1	Defrosting maximum speed	1~25	12min	Adjustable
H2	Stop defrosting temperature	1~25	12°C	Adjustable
H3	Start defrosting temperature	-20~20	-1°C	Adjustable
F0	Heating temperature difference before start	0°C~18°C	0°C	Adjustable
F1	Heating temperature difference before stop	0°C~18°C	2°C	Adjustable
F2	EEV adjust period	10~60 s	30s	Adjustable
F3	Cooling temperature difference before start	0°C~18°C	0°C	Adjustable
F4	Cooling temperature difference before stop	0°C~18°C	2°C	Adjustable
P0	Compensate temperature	-9~9°C	0°C	Adjustable
P1	Reserve			Adjustable
P2	Reserve			Adjustable
P3	Minimum working temperature	-19~15°C	-8°C	Adjustable
P4	Minimum ambient temperature difference	2~18°C	2°C	Adjustable
P5	Operation mode	Range: 0~3 0=Heating only 1=Cooling only 2=Cooling and heating 3=Cooling,heating and Auto	3	Réglable
P6	Auxiliary heater	On / Off	OFF	
P7	Temperature auxiliary heater start	2~15°C	5°C	Adjustable
P8	Temperature difference between inlet and outlet protection	2~60°C	10°C	Adjustable
P9	Bottom plate heater temperature start	-9~10°C	0°C	Adjustable
P10	High fan speed	300~1500	83	Adjustable
P11	Mid fan speed		68	Adjustable
P12	Low fan speed		52	Adjustable
P13	Reserve			
P14	Reserve			
P15	Reserve			
P16	Reserve			
P17	EEV Maximum opening	50~480	480P	Adjustable
P18	EEV Minimum opening	50~300	80P	Adjustable
P19	Reserve			
P20	Forced recycle refrigerant	OF: OFF ON: ON	OF	Adjustable
P22	Heating maximum setting temperature	35~60°C	40°C	Adjustable
P23	Heating minimum setting temperature	15~25°C	15°C	Adjustable
P24	Cooling maximum setting temperature	25~35°C	28°C	Adjustable
P25	Cooling minimum setting temperature	2~10°C	8°C	Adjustable
C0	Test mode	On / Off	Off	
C1	Test mode compressor manually	10~120	50Hz	
C2	Test mode EEV manually opening	60 ~ 480	350P	
C3	Test mode fan speed	1 ~ 150 AC : 1:H, 2:M, 3:L DC: value*10 Range : 300~1500	82	

POOLEX



TECHNICAL ASSISTANCE

sav@gapfpc.fr