

POOLEX

**INSTALLATION
AND
USER MANUAL**
for your heat pump

JetBlack



Modèles 55 / 70 / 90 / 120 / 150

Warning



This heat pump contains a flammable refrigerant R32.

Any intervention on the refrigerant circuit is prohibited without a valid authorization.

Before working on the refrigerant circuit, the following precautions are necessary for safe work.

1. Work procedure

The work must be carried out according to a controlled procedure, in order to minimize the risk of presence of flammable gases or vapors during the execution of the works.

2. General work area

All persons in the area must be informed of the nature of the work in progress. Avoid working in a confined area. The area around the work area should be divided, secured and special attention should be paid to nearby sources of flame or heat.

3. Verification of the presence of refrigerant

The area should be checked with a suitable refrigerant detector before and during work to ensure that there is no potentially flammable gas. Make sure that the leak detection equipment used is suitable for flammable refrigerants, ie it does not produce sparks, is properly sealed or has internal safety.

4. Presence of fire extinguisher

If hot work is to be performed on the refrigeration equipment or any associated part, appropriate fire extinguishing equipment must be available. Install a dry powder or CO2 fire extinguisher near the work area.

5. No source of flame, heat or spark

It is totally forbidden to use a source of heat, flame or spark in the direct vicinity of one or more parts or pipes containing or having contained a flammable refrigerant. All sources of ignition, including smoking, must be sufficiently far from the place of installation, repair, removal and disposal, during which time a flammable refrigerant may be released into the surrounding area. Before starting work, the environment of the equipment should be checked to ensure that there is no risk of flammability. «No smoking» signs must be posted.

6. Ventilated area

Make sure the area is in the open air or is properly ventilated before working on the system or performing hot work. Some ventilation must be maintained during the duration of the work.

7. Controls of refrigeration equipment

When electrical components are replaced, they must be suitable for the intended purpose and the appropriate specifications. Only the parts of the manufacturer can be used. If in doubt, consult the technical service of the manufacturer.

The following controls should be applied to installations using flammable refrigerants:

- The size of the load is in accordance with the size of the room in which the rooms containing the refrigerant are installed;*
- Ventilation and air vents work properly and are not obstructed;*
- If an indirect refrigeration circuit is used, the secondary circuit must also be checked.*
- The marking on the equipment remains visible and legible. Illegible marks and signs must be corrected;*
- Refrigeration pipes or components are installed in a position where they are unlikely to be exposed to a substance that could corrode components containing refrigerant*

8. Verification of electrical appliances

Repair and maintenance of electrical components must include initial safety checks and component inspection procedures. If there is a defect that could compromise safety, no power supply should be connected to the circuit until the problem is resolved.

Initial security checks must include:

- That the capacitors are discharged: this must be done in a safe way to avoid the possibility of sparks;*
- No electrical components or wiring are exposed during loading, recovery or purging of the refrigerant gas system;*
- There is continuity of grounding.*

Thank you

Dear Customer,

Thank you for your purchase and for your confidence in our products.

These are the result of many years of research in the field of design and production of heat pumps for swimming pools. Our aim is to provide you with an exceptional high performance quality product.

We have produced this manual with the utmost care so that you get maximum benefit from your Poolex heat pump.



PLEASE READ CAREFULLY.



**These installation instructions are an integral part of the product.
They must be given to the installer and retained by the user.
If the manual is lost, please consult the website:**

www.poolex.fr

The instructions and recommendations contained in this manual should be read carefully and understood since they provide valuable information concerning the heat pump's safe handling and operation. **Keep this manual in an accessible place for easy future reference.**

Installation must be carried out by a qualified professional person in accordance with current regulations and the manufacturer's instructions. An installation error may cause physical injury to persons or animals as well as mechanical damage for which the manufacturer can under no circumstances be held responsible.

After unpacking the heat pump, please check the contents in order to report any damage.

Prior to connecting the heat pump, ensure that the information provided in this manual is compatible with the actual installation conditions and does not exceed the maximum limits authorised for this particular product.

In the event of a defect and/or malfunction of the heat pump, the electricity supply must be disconnected and no attempt made to repair the fault.

Repairs must be undertaken only by an authorised technical service organisation using original replacement parts. Failure to comply with the above-mentioned clauses may have an adverse effect on the heat pump's safe operation.

To guarantee the heat pump's efficiency and satisfactory operation, it is important to ensure its regular maintenance in accordance with the instructions provided.

If the heat pump is sold or transferred, always make sure that all technical documentation is transmitted with the equipment to the new owner.

This heat pump is designed solely for heating a swimming pool. Any other use must be considered as being inappropriate, incorrect or even hazardous.

Any contractual or non-contractual liability of the manufacturer/distributor shall be deemed null and void for damage caused by installation or operational errors, or due to non-compliance with the instructions provided in this manual or with current installation norms applicable to the equipment covered by this document.

Contents

1. General	6
1.1 General Terms of Delivery	6
1.2 Safety instructions	6
1.3 Water treatment	7
2. Description	8
2.1 Package contents	8
2.2 General characteristics	8
2.3 Technical specifications	9
2.4 Unit dimensions	10
2.5 Exploded view	11
3. Installation	12
3.1 Pre-requirements	12
3.2 Location	12
3.3 Installation layout	13
3.4 Connecting the condensation draining kit	13
3.5 Installing the unit on noise-damping supports	13
3.6 Hydraulic connection	14
3.7 Electrical installation	16
3.8 Electrical connection	17
3.9 Wall-mounting the remote control	18
4. Use	19
4.1 Wired remote control	19
4.2 Operating mode selector	19
4.3 Heating Mode	20
4.4 Setting the clock	21
4.5 Programming Start/Stop	22
4.6 Activating a programme	23
4.7 Deactivating a programme	23
4.8 Status values and advanced settings	24
5. Operation	26
5.1 Operation	26
5.2 Servo-control of circulating pump	27
5.3 Using the pressure gauge	27
5.4 Antifreeze protection	28
6. Maintenance and servicing	29
6.1 Maintenance and servicing	29
6.2 Winter storage	29
7. Repairs	30
7.1 Breakdowns and faults	30
7.2 List of faults	31
8. Recycling	32
8.1 Recycling the heat pump	32
9. Warranty	33
9.1 General warranty conditions	33
10. Appendices	34
10.1 Wiring diagrams	34

1. General

1.1 General Terms of Delivery

All equipment, even if shipped 'free of carriage and packing', is dispatched at the consignee's own risk

The person responsible for receiving the equipment must carry out a visual inspection to identify any damage to the heat pump during transport (refrigerant system, body panels, electrical control box, frame). He/she must note down on the carrier's delivery note any remarks concerning damage caused during transport and confirm them to the carrier by registered letter within 48 hours.

The equipment must always be stored and transported vertically on a pallet and in its original packaging. If

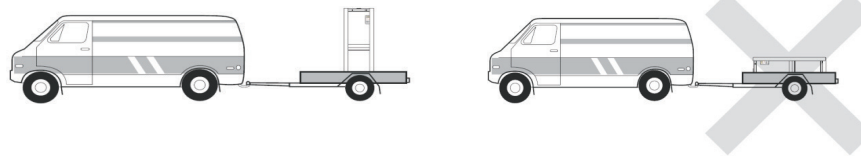

it is stored or transported horizontally, wait at least 24 hours before switching it on.

1.2 Safety instructions



WARNING: Please read carefully the safety instructions before using the equipment. The following instructions are essential for safety so please strictly comply with them.

During installation and servicing

Only a qualified person may undertake installation, start-up, servicing and repairs, in compliance with current standards.

Before operating or undertaking any work on the equipment (installation, commissioning, usage, servicing), the person responsible must be aware of all the instructions in the heat pump's installation manual as well as the technical specifications.

Under no circumstances install the equipment close to a source of heat, combustible materials or a building's air intake.

If installation is not in a location with restricted access, a heat pump protective grille must be fitted.

To avoid severe burns, do not walk on pipework during installation, repairs or maintenance.

To avoid severe burns, prior to any work on the refrigerant system, turn off the heat pump and wait several minutes before placing temperature and pressure sensors.

Check the refrigerant level when servicing the heat pump.

Check that the high and low pressure switches are correctly connected to the refrigerant system and that they turn off the electrical circuit if tripped during the equipment's annual leakage inspection.

Check that there is no trace of corrosion or oil stains around the refrigerant components.

1. General

During use

To avoid serious injuries, never touch the fan when it is operating.

Keep the heat pump out of the reach of children to avoid serious injuries caused by the heat exchanger's blades.

Never start the equipment if there is no water in the pool or if the circulating pump is stopped.

Check the water flow rate every month and clean the filter if necessary.

During cleaning

Switch off the equipment's electricity supply.

Close the water inlet and outlet valves.

Do not insert anything into the air or water intakes or outlets.

Do not rinse the equipment with water.

During repairs

Carry out work on the refrigerant system in accordance with current safety regulations.

Brazing should be performed by a qualified welder.

When replacing a defective refrigerant component, use only parts certified by our technical department.

When replacing pipework, only copper pipes conforming to Standard NF EN12735-1 may be used for repairs.

When pressure-testing to detect leaks:

To avoid the risks of fire or explosion, never use oxygen or dry air.

Use dehydrated nitrogen or a mixture of nitrogen and refrigerant.

The low and high side test pressure must not exceed 42 bar.

1.3 Water treatment

Poolex heat pumps for swimming pools can be used with all types of water treatment systems.

Nevertheless, it is essential that the treatment system (chlorine, pH, bromine and/or salt chlorinator metering pumps) is installed after the heat pump in the hydraulic circuit.

To avoid any deterioration to the heat pump, the water's pH must be maintained between 6.9 and 8.0.

2. Description

2.1 Package contents

- ◆ Heat pump Poolex Jetblack
- ◆ 2 hydraulic inlet/outlet connectors 50mm diameter (Jetblack MINI : 32/38mm)
- ◆ Extension cable for remote control panel (except Jetblack MINI)
- ◆ This installation and user manual
- ◆ Condensation draining kit
- ◆ **Winter storage cover**
- ◆ **4 anti-vibration pads (fastenings not supplied)**

2.2 General characteristics

A Poolex heat pump has the following features:

- ◆ CE certification and complies with the RoHS European directive.
- ◆ High performance with up to 80% energy savings compared to a conventional heating system.
- ◆ Clean, efficient and environmentally friendly R32 refrigerant.
- ◆ Reliable high output leading brand compressor.
- ◆ Wide hydrophilic aluminium evaporator for use at low temperatures.
- ◆ User-friendly intuitive remote control.
- ◆ Heavy duty shell, anti-UV treated and easy to maintain.
- ◆ Designed to be silent.
- ◆ Dual antifreeze system to avoid frost damage:

Revolutionary exchanger with patented antifreeze system.

A smart monitoring system to preserve the pipework and liner without emptying the pool in winter.

2. Description

2.3 Technical specifications

Test conditions		Jetblack				
		55	70	90	120	150
Air ⁽¹⁾ 26°C Water ⁽²⁾ 26°C	Heating power (W)	5390	7020	9310	12500	15240
	Consumption (W)	880	1130	1510	2010	2460
	COP (Coeff. of performance)	6.13	6.21	6.17	6.22	6.20
Air ⁽¹⁾ 15°C Water ⁽²⁾ 13°C	Heating power (W)	4400	5510	7160	9500	11560
	Consumption (W)	720	890	1160	1530	1830
	COP (Coeff. of performance)	6.11	6.19	6.17	6.21	6.32
Air ⁽¹⁾ 15°C Water ⁽²⁾ 26°C	Heating power (W)	3900	5070	7050	9050	10590
	Consumption (W)	805	1010	1390	1780	2070
	COP (Coeff. of performance)	4.84	5.02	5.07	5.08	5.12
Maximum power (W)		1290	1830	2510	3030	3580
Maximum current (A)		6.3	8.9	11.5	14.5	16.4
Electricity supply		Single phase 230V~50Hz				
Heating temperature range		15°C~40°C				
Operating range		5°C~43°C				
Unit dimensions L x W x H (mm)		765 x 310 x 490	827 x 340 x 531	927 x 340 x 636		
Unit weight (kg)		39	41	49	52	54
Sound pressure level at 1 m (dBA) ⁽³⁾		<46	<46	<47	<48	<49
Sound pressure level at 4 m (dBA) ⁽³⁾		<39	<40	<42	<43	<45
Sound pressure level at 10 m (dBA) ⁽³⁾		<30	<36	<37	<38	<39
Hydraulic connection (mm)		PVC 50mm				
Heat exchanger		PVC tank and titanium heating coil				
Min. water flow rate (m ³ /h)		1.86	2.5	3.2	4.0	4.7
Compressor		GMCC	GMCC	GMCC	GMCC	GMCC
Compressor type		Rotary				
Refrigerant		R32				
Load loss (mCE)		0.9	0.9	1	1.1	1.13
Max. pool volume (m ³) ⁽⁴⁾		≤25	≤35	≤45	≤60	≤75
Remote control		Wired backlit LCD monitor screen				
Mode		Heating				

The technical specifications of our heat pumps are provided for information purposes only. We reserve the right to make changes without prior notice.

¹ Ambient air temperature

² Initial water temperature

³ Noise at 1 m, at 4 m and at 10 m in accordance with Directives EN ISO 3741 and EN ISO 354

⁴ Calculated for an in-ground private swimming pool covered with a bubble cover.

⁵ Value indicated on the unit's nameplate.

2. Description

2.4 Unit dimensions

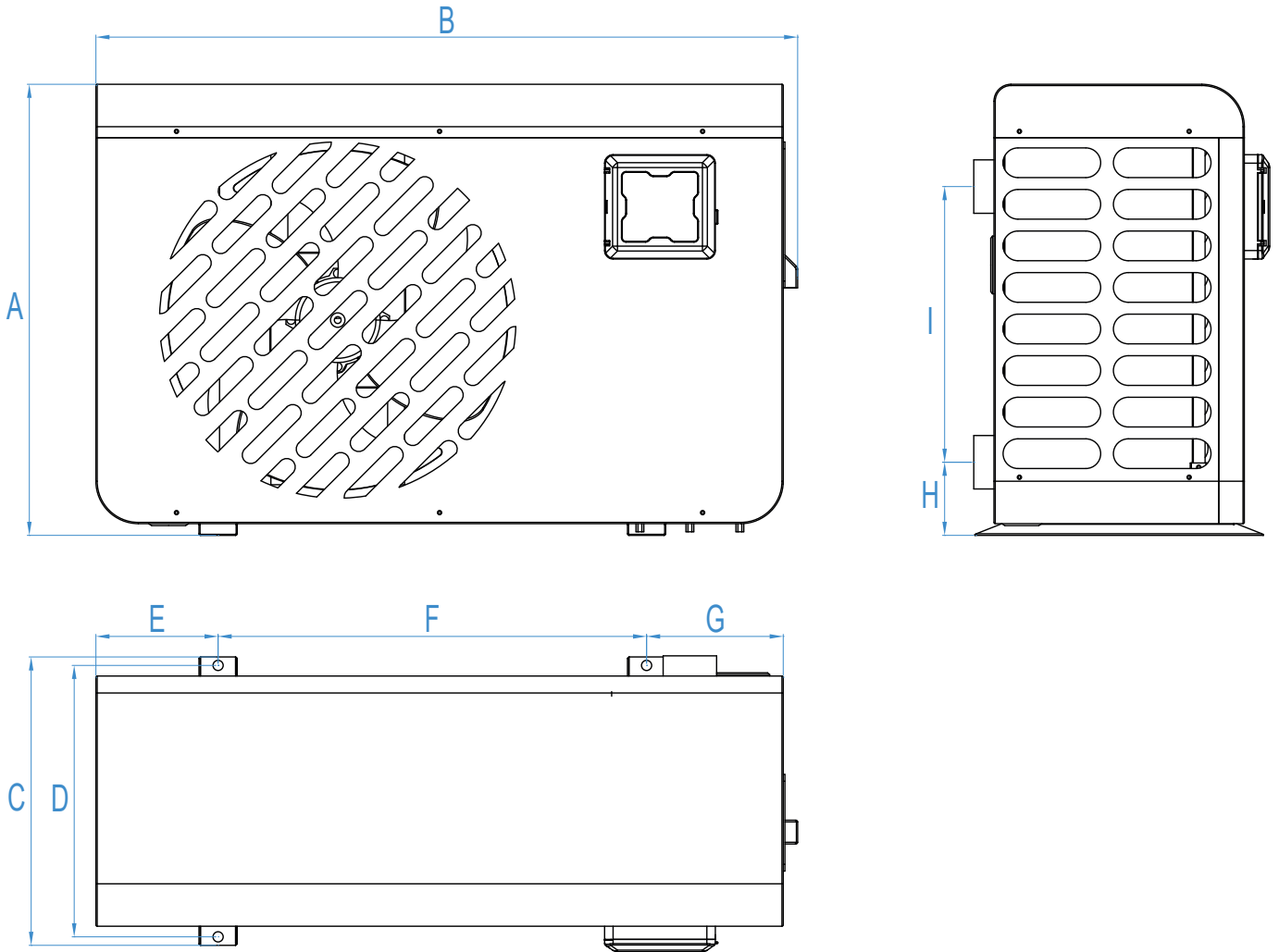

Dimensions in mm

	Jetblack 55	Jetblack 70	Jetblack 90 / 120 / 150
A	490	532	636
B	765	827	927
C	310	340	340
D	290	320	320
E	142	144	161
F	480	505	605
G	128	161	144
H	86	86	86
I	280	325	370

2. Description

2.5 Exploded view

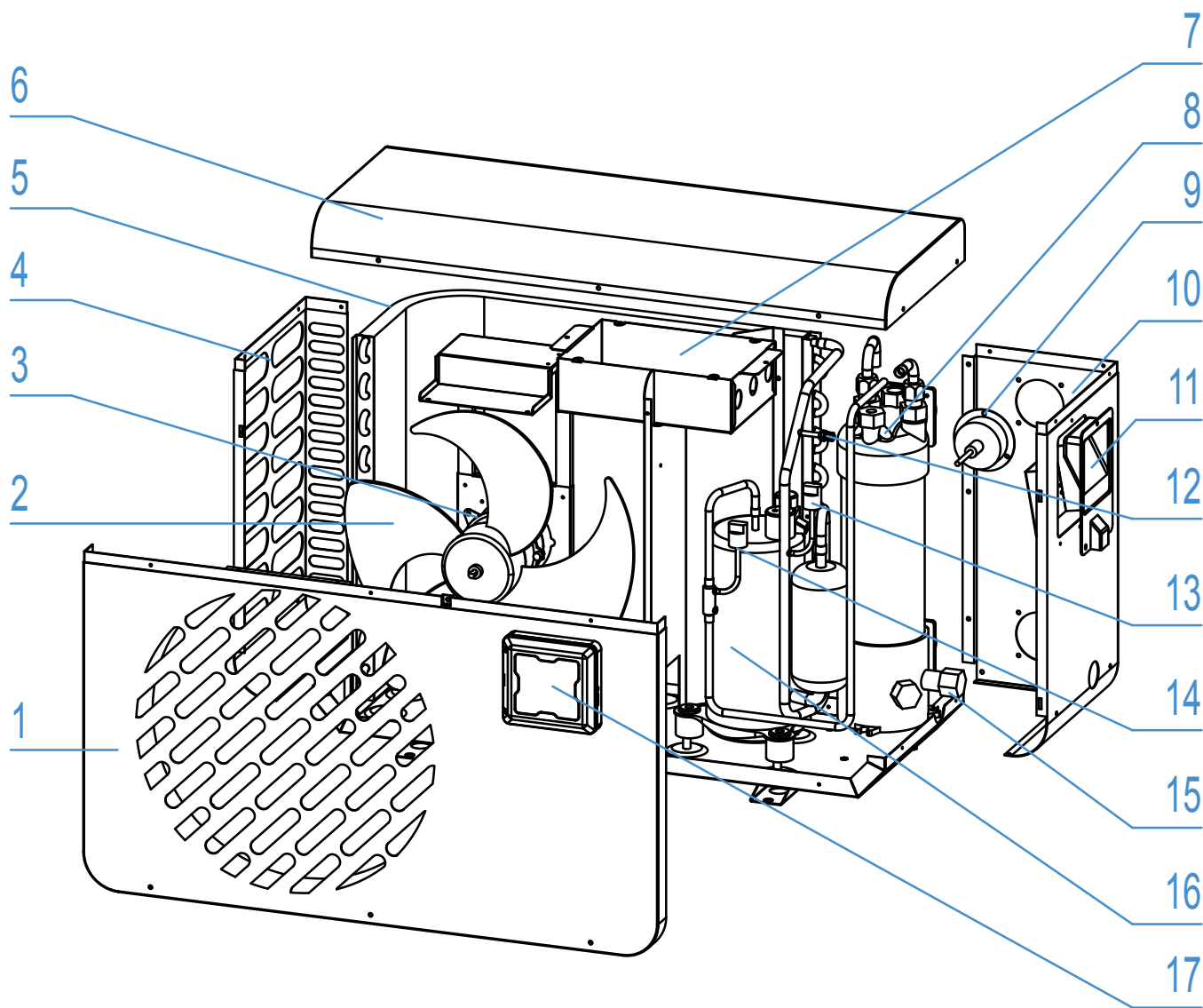

- | | |
|---------------------------|---|
| 1. Front panel | 10. Right side panel |
| 2. Fan blade | 11. Couvercle du boîtier électrique |
| 3. Fan motor | 12. Service valve |
| 4. Left side panel | 13. Low pressure sensor |
| 5. Evaporator | 14. High pressure sensor |
| 6. Top panel | 15. Drain plug |
| 7. Electrical control box | 16. Compresseur |
| 8. Heat exchanger | 17. Sealed enclosure for remote control |
| 9. Pressure gauge | |

3. Installation



WARNING: Installation must be carried out by a qualified engineer.

This section is provided for information purposes only and must be checked and adapted if necessary according to the actual installation conditions.

3.1 Pre-requirements

Equipment necessary for the installation of your heat pump:

Power supply cable suitable for the unit's power requirements.

A *By-Pass* kit and an assembly of PVC tubing suitable for your installation as well as stripper, PVC adhesive and sandpaper.

A set of wall plugs and expansion screws suitable to attach the unit to your support.

We recommend that you connect the unit to your installation by means of flexible PVC pipes in order to reduce the transmission of vibrations.

Suitable fastening studs may be used to raise the unit.

3.2 Location

Please comply with the following rules concerning the choice of heat pump location.

1. The unit's future location must be easily accessible for convenient operation and maintenance.
2. It must be installed on the ground, fixed ideally on a level concrete floor. Ensure that the floor is sufficiently stable and can support the weight of the unit.
3. A water drainage device must be provided close to the unit in order to protect the area where it is installed.
4. If necessary, the unit may be raised by using suitable mounting pads designed to support its weight.
5. Check that the unit is properly ventilated, that the air outlet is not facing the windows of neighbouring buildings and that the exhaust air cannot return. In addition, provide sufficient space around the unit for servicing and maintenance operations.
6. The unit must not be installed in an area exposed to oil, flammable gases, corrosive products, sulphurous compounds or close to high frequency equipment.
7. To prevent mud splashes, do not install the unit near a road or track.
8. To avoid causing nuisance to neighbours, make sure the unit is installed so that it is positioned towards the area that is least sensitive to noise.
9. Keep the unit as much as possible out of the reach of children.

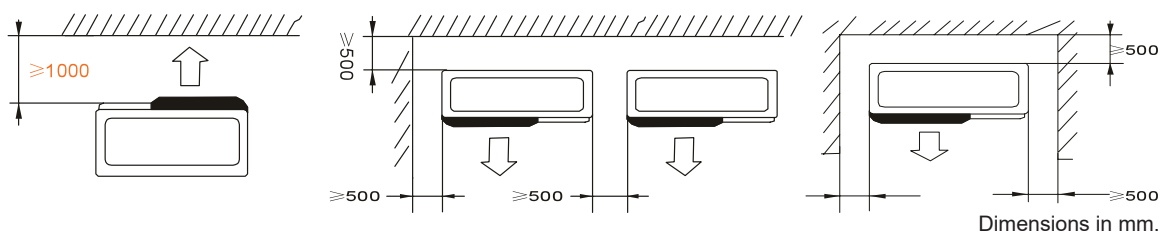

Place nothing less than one metre in front of the heat pump.
Leave 50 cm of empty space around the sides and rear of the heat pump.

Do not leave any obstacle above or in front of the unit!

3. Installation

3.3 Installation layout

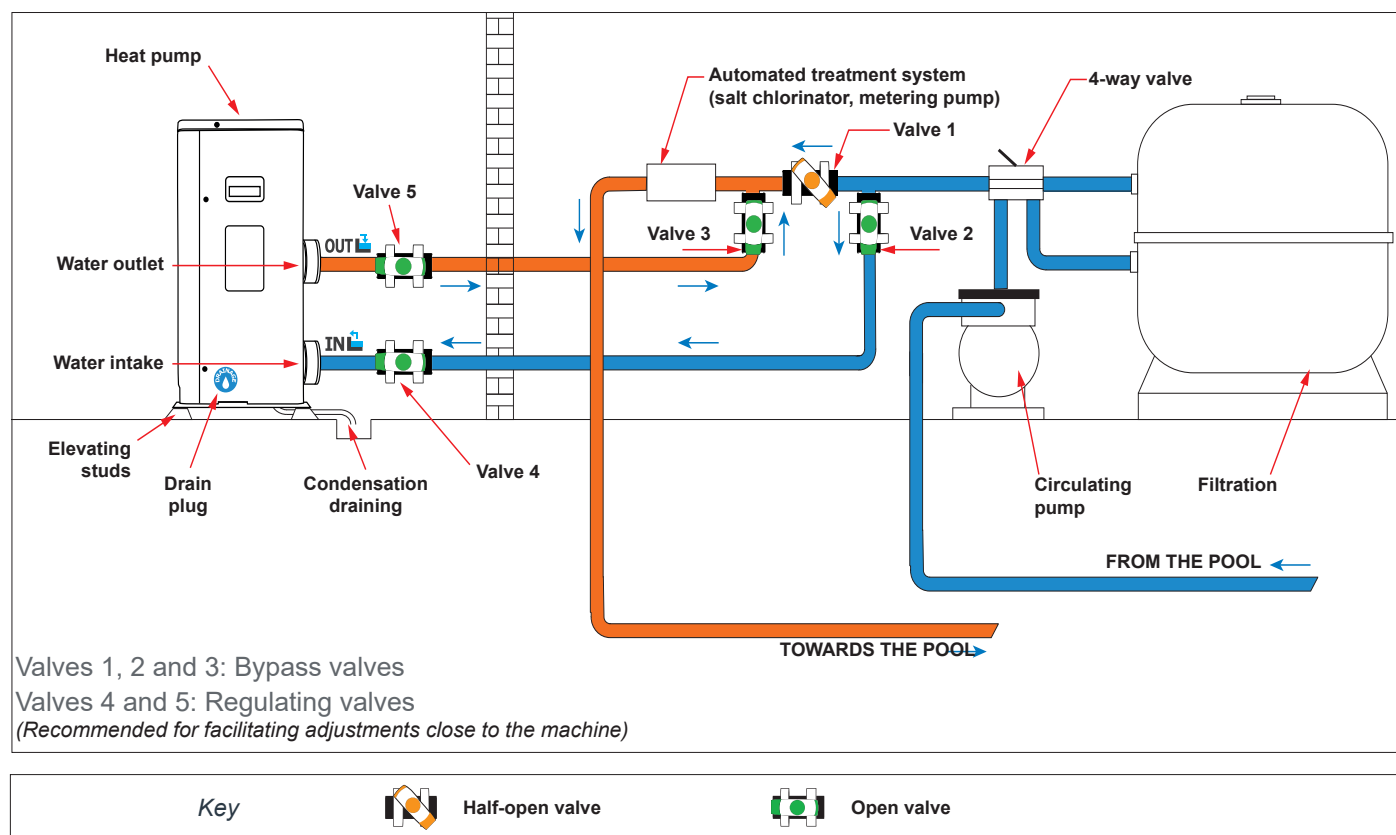

3.4 Connecting the condensation draining kit

While operating, the heat pump is subject to condensation. This will result in a more or less large run-off of water, depending on the degree of humidity. To channel this flow, we recommend that you install the condensation drainage kit.

How do you install the condensation drainage kit?

Install the heat pump, raising it at least 10 cm with solid water-resistant pads, then connect the drainage pipe to the opening located under the pump.

3.5 Installing the unit on noise-damping supports

In order to minimise the noise pollution associated with heat pump vibrations, it can be positioned on vibration absorbing pads.

To do this, you simply have to position a pad between each of the unit's feet and its support, and then fix the heat pump to the support with suitable screws.

3. Installation



WARNING: Installation must be carried out by a qualified engineer.

This section is provided for information purposes only and must be checked and adapted if necessary according to the actual installation conditions.

3.6 Hydraulic connection

By-Pass assembly

The heat pump must be connected to the pool by means of a By-Pass assembly.

A By-Pass is an assembly consisting of 3 valves that regulate the flow circulating in the heat pump. During maintenance operations, the By-Pass permits the heat pump to be isolated from the system without interrupting your installation.

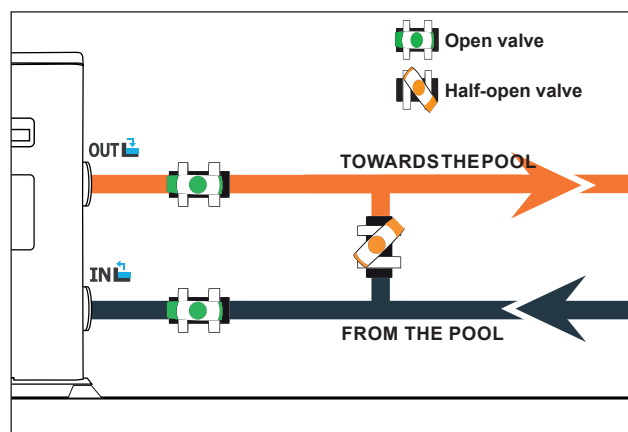

Making a hydraulic connection with the By-Pass kit



WARNING: Do not run water through the hydraulic circuit for 2 hours after applying the adhesive.

Step 1: Take the necessary steps to cut your pipes.

Step 2: Make a straight perpendicular cut through the PVC pipes with a saw.

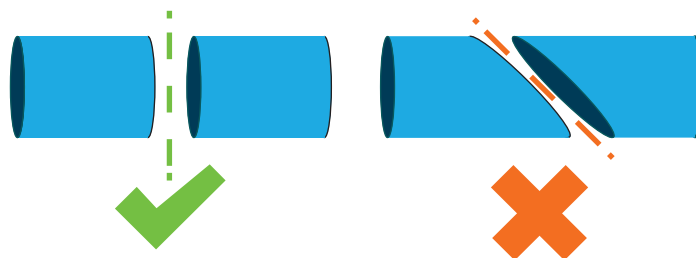

Step 3: Assemble your hydraulic circuit without connecting it in order to check that it perfectly fits your installation, then dismantle the pipes to be connected.

Step 4: Chamfer the ends of the cut pipes with sandpaper.

Step 5: Apply stripper to the ends of the pipes to be connected.

Step 6: Apply the adhesive in the same place.

Step 7: Assemble the pipes.

Step 7: Clean off any adhesive remaining on the PVC.

Step 8: Leave to dry for at least 2 hours before putting the hydraulic circuit into water.

3. Installation

By-Pass assembly for one heat pump

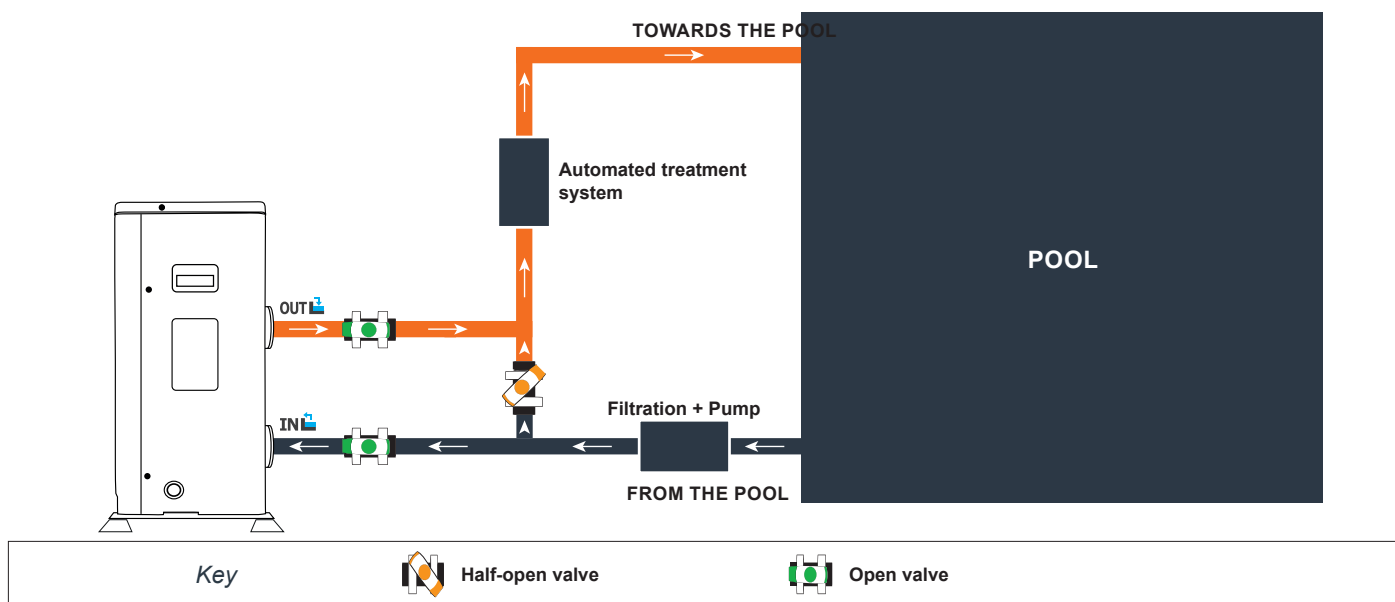

By-Pass assembly for more than one heat pump

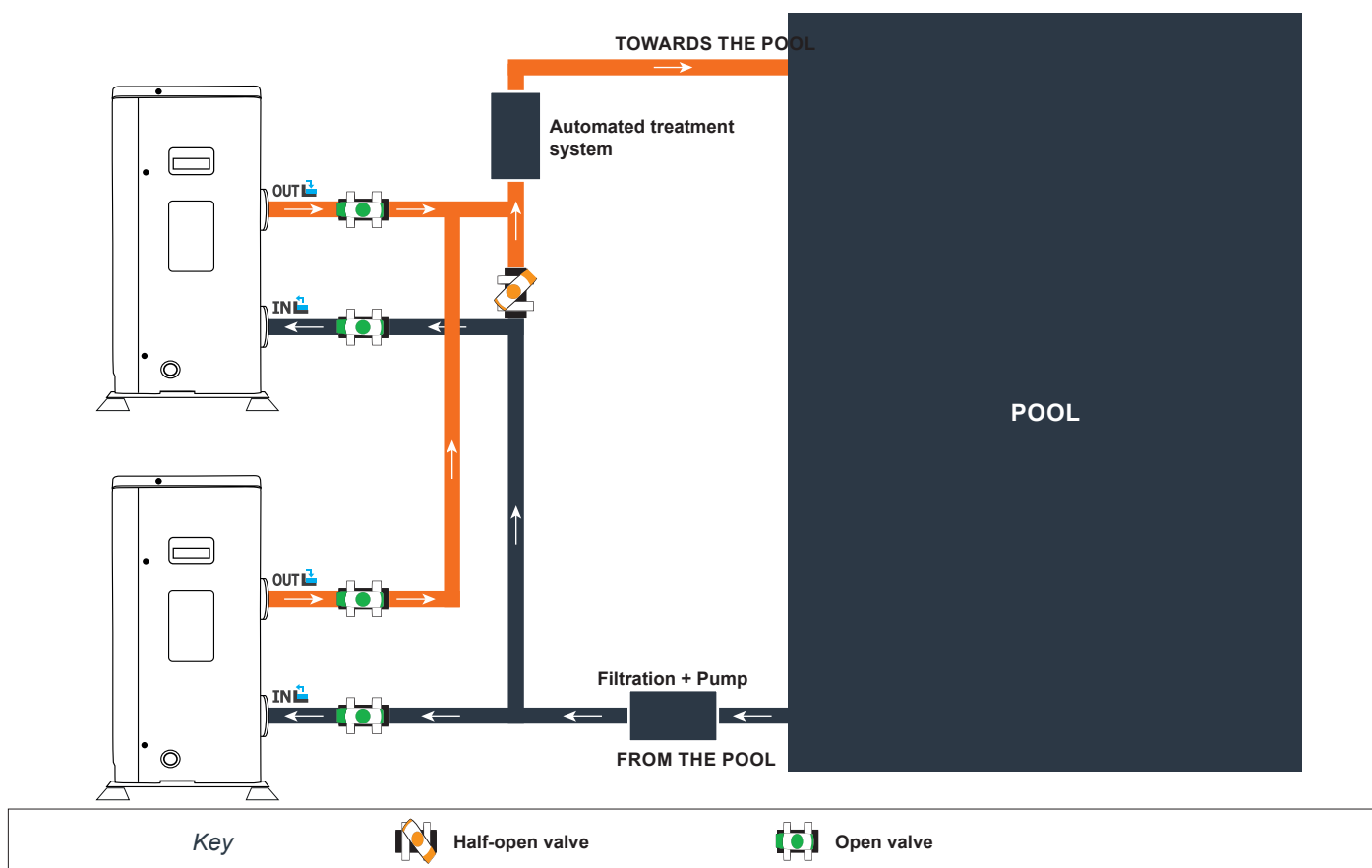

The filter located upstream of the heat pump must be regularly cleared so that the water in the system is clean, thus avoiding the operational problems associated with dirt or clogging in the filter.

3. Installation



WARNING: Installation must be carried out by a qualified engineer.

This section is provided for information purposes only and must be checked and adapted if necessary according to the actual installation conditions.

3.7 Electrical installation

To function safely and maintain the integrity of your electrical system, the unit must be connected to a general electricity supply in accordance with the following regulations:

Upstream, the general electricity supply must be protected by a 30 mA differential switch.

The heat pump must be connected to a suitable D-curve circuit breaker (see table below) in accordance with current standards and regulations in the country where the system is installed.

The electricity supply cable must be adapted to match the unit's rated power and the length of wiring required by the installation (see table below). The cable must be suitable for outdoor use.

For a three-phase system, it is essential to connect the phases in the correct sequence. If the phases are inverted, the heat pump's compressor will not work.

In places open to the public, it is mandatory to install an emergency stop button close to the heat pump.

Models	Electricity supply	Max. current	Cable diameter	Protection Thermal-magnetic (D curve) protection
Jetblack 55	Single phase 230V~50Hz	6,3	RO2V 3x2.5 mm ²	10A
Jetblack 70		8,9	RO2V 3x2.5 mm ²	16A
Jetblack 90		11,5	RO2V 3x2.5 mm ²	16A
Jetblack 120		14,5	RO2V 3x4 mm ²	20A
Jetblack 150		16.4	RO2V 3x4 mm ²	20A

¹ Cable cross-section suitable for max. length 30 metres. For longer than 30 metres, consult an electrician.

3. Installation

3.8 Electrical connection



WARNING: The heat pump's power supply MUST be disconnected before any operation.

Please comply with the following instructions to electrically connect the heat pump.

Step 1: Detach the electrical side panel with a screwdriver to access the electrical terminal block.

Step 2: Insert the cable into the heat pump unit by passing it through the opening provided for that purpose.

Step 3: Connect the power supply cable to the terminal block in accordance with the diagram below.

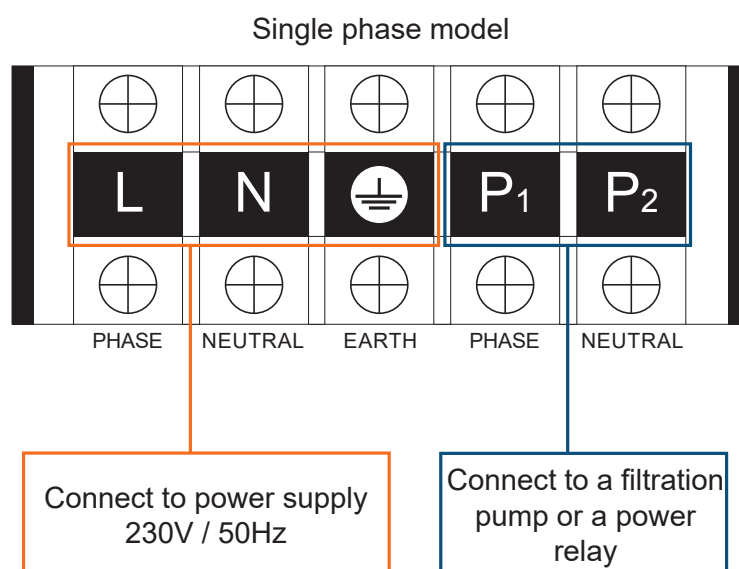

Step 4: Carefully close the heat pump panel.

Servo-control of circulating pump

Depending on the type of installation, you can also connect a circulating pump to terminals P1 and P2 so that this operates in tandem with the heat pump.



WARNING: Servo-control of a pump whose power exceeds 5A (1000W) requires the use of a power relay.

3. Installation

3.9 Wall-mounting the remote control

Step 1: Detach the remote control from the machine. Pay attention to the communication wire connected to the printed circuit board and separate them carefully.

Step 2: Use a screwdriver to open the casing and separate the remote control.

Step 3: Drill two parallel holes at eye level: 60 mm centre-to-centre.

Step 4: Attach the remote control's rear cover to the wall.

Step 5: Align the front and rear covers exactly, ensuring that the box is fixed firmly to the wall.

Step 6: Carefully connect the communication wire.

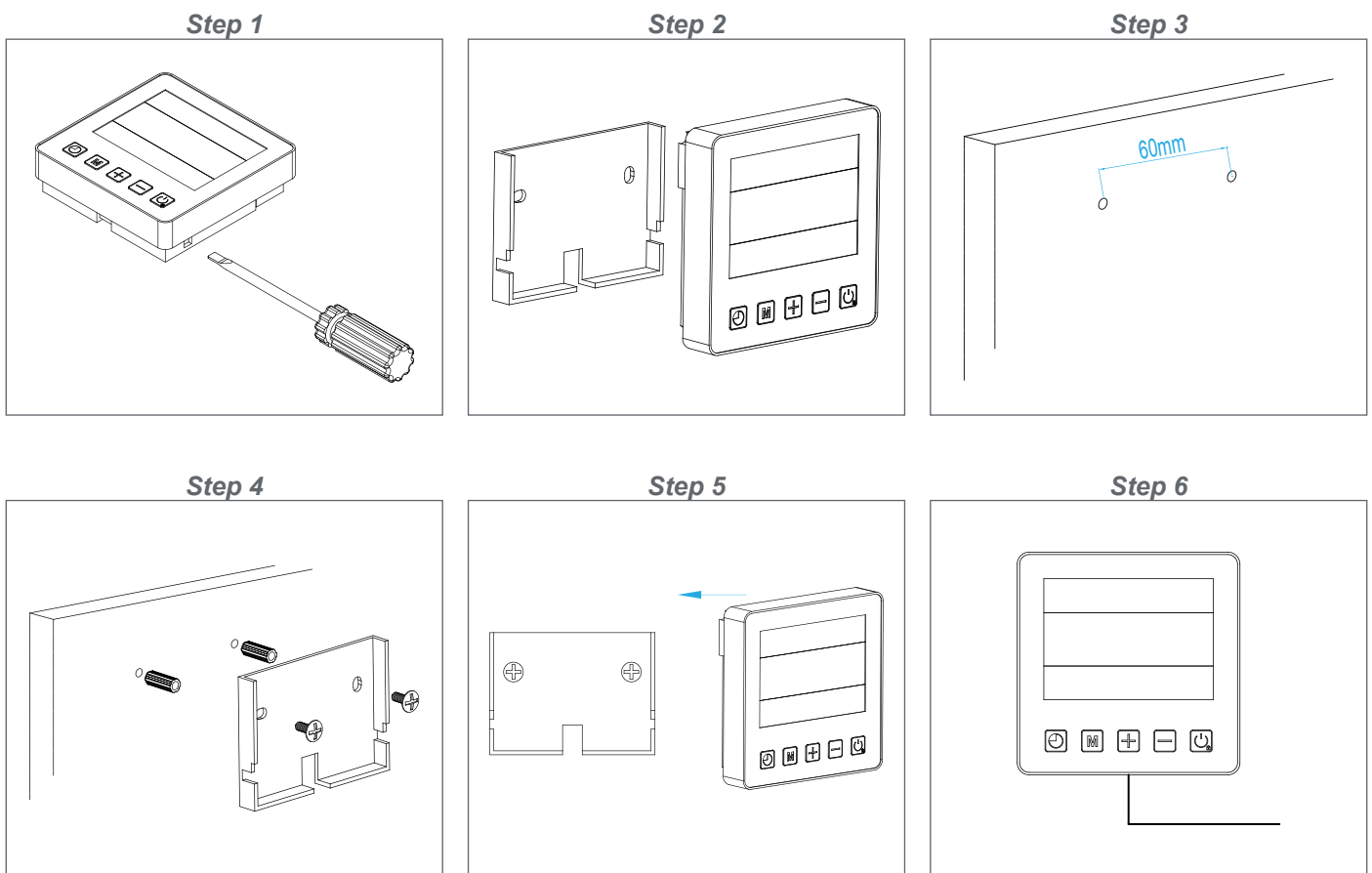

WARNING: Do not use sharp objects to touch the remote control's front face and buttons as you may damage it. When the remote control is fixed to the wall, do not pull the communication wire, this may cause a loose contact.

4. Use

4.1 Wired remote control

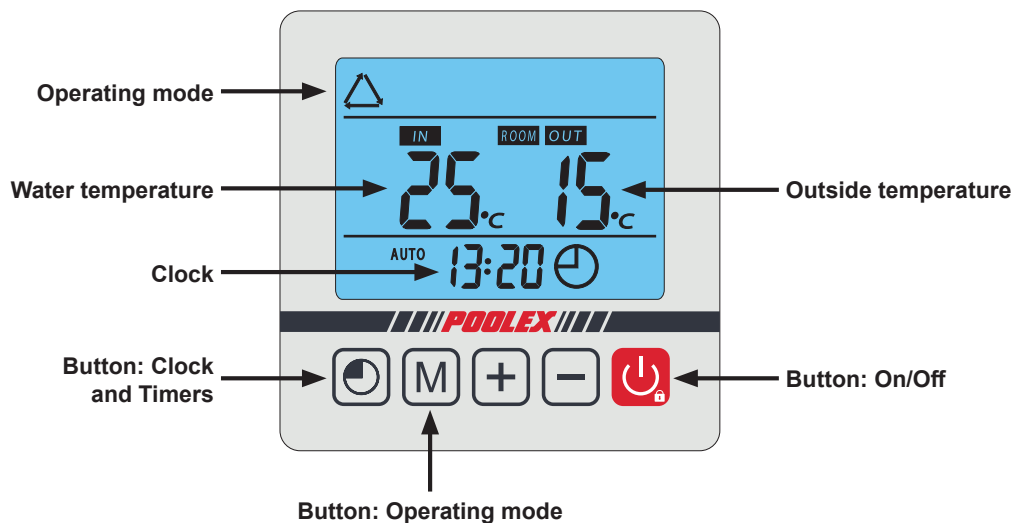

4.2 Operating mode selector



Before starting, ensure that the filtration pump is working and that water is circulating through the heat pump.

Prior to setting your required temperature, you must first select an operating mode for your heat pump:

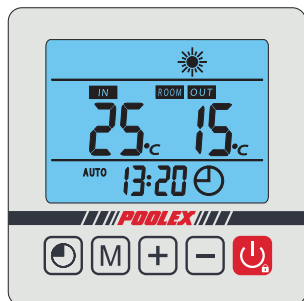

Heating Mode

Select the heating mode  for the heat pump to heat the water in your pool.

4. Use

4.3 Heating Mode



WARNING: Before starting, ensure that the filtration pump is operating correctly.

Step 1: Press  to switch on your pump.

Step 2: Press  to switch from one mode to another until the heating mode is displayed. **Step 3:**

Using buttons  and  select the required temperature (15-40°C).

EXAMPLE:

If you have selected 28°C, your screen will display:

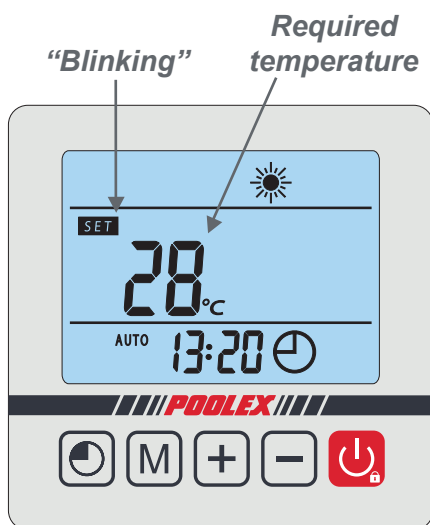

Once the symbol **SET** stops blinking, the required temperature is validated and is replaced by the water's current temperature (25° in our example).

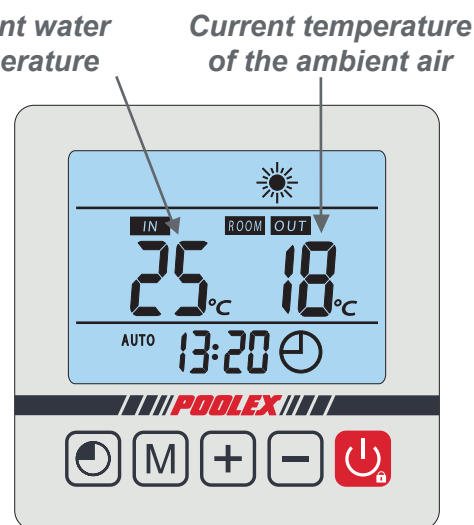

Useful information about how the heating mode operates

When the incoming water temperature is less than or equal to the required temperature (setpoint temperature) -X°C, the heat pump will switch to heating mode. The compressor will stop when the temperature of the incoming water is greater than or equal to the required temperature (setpoint temperature) +Y°C.

Indicators for adjustment range X and Y

X : adjustable parameter from 2° to 10°C, default setting is 3°C

Y : adjustable parameter from 0° to 6°C, default setting is 0°C

4. Use

4.4 Setting the clock



Set the system clock to local time, as follows:

Step 1: Press  to set the time, the symbol  is blinking.

Step 2: Press  to select the hour.

Step 3: Adjust the hours with the buttons  and .

Step 4: Press  to switch to minutes.

Step 5: Adjust the minutes with the buttons  and .

Step 6: Press  to validate and return to the main screen.

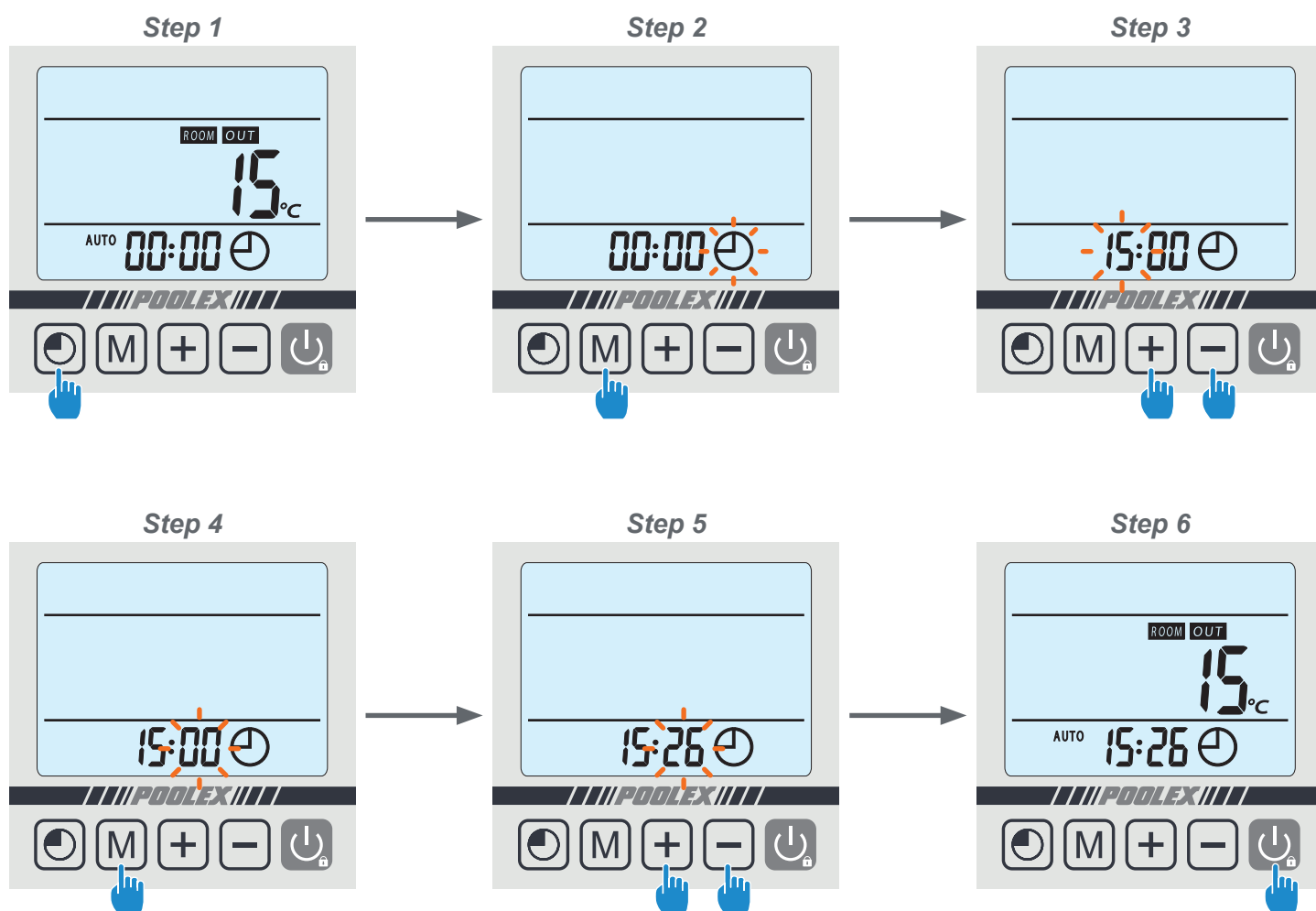

4. Use

4.5 Programming Start/Stop

This function is for programming the Start/Stop timing. You can programme up to 3 different Start/Stop timings. Setting is as follows:

Step 1: Select the programme to be configured,

- Press twice to select programme 1.
- Press 3 times to select programme 2.
- Press 4 times to select programme 3.

Step 2: Press to programme the start time.

Step 3: Adjust the hours with the buttons and .

Step 4: Press to switch to minutes.

Step 5: Adjust the minutes with the buttons and .

Step 6: Press to programme the stop time.

Step 7: Adjust the hours with the buttons and .

Step 8: Press to switch to minutes.

Step 9: Adjust the minutes with the buttons and .

Step 10: Press to validate the programme.

Step 11: Press to return to the main screen.

NB: The remote control returns automatically to the main screen after 10 seconds.

Refer to the following section to activate the programme

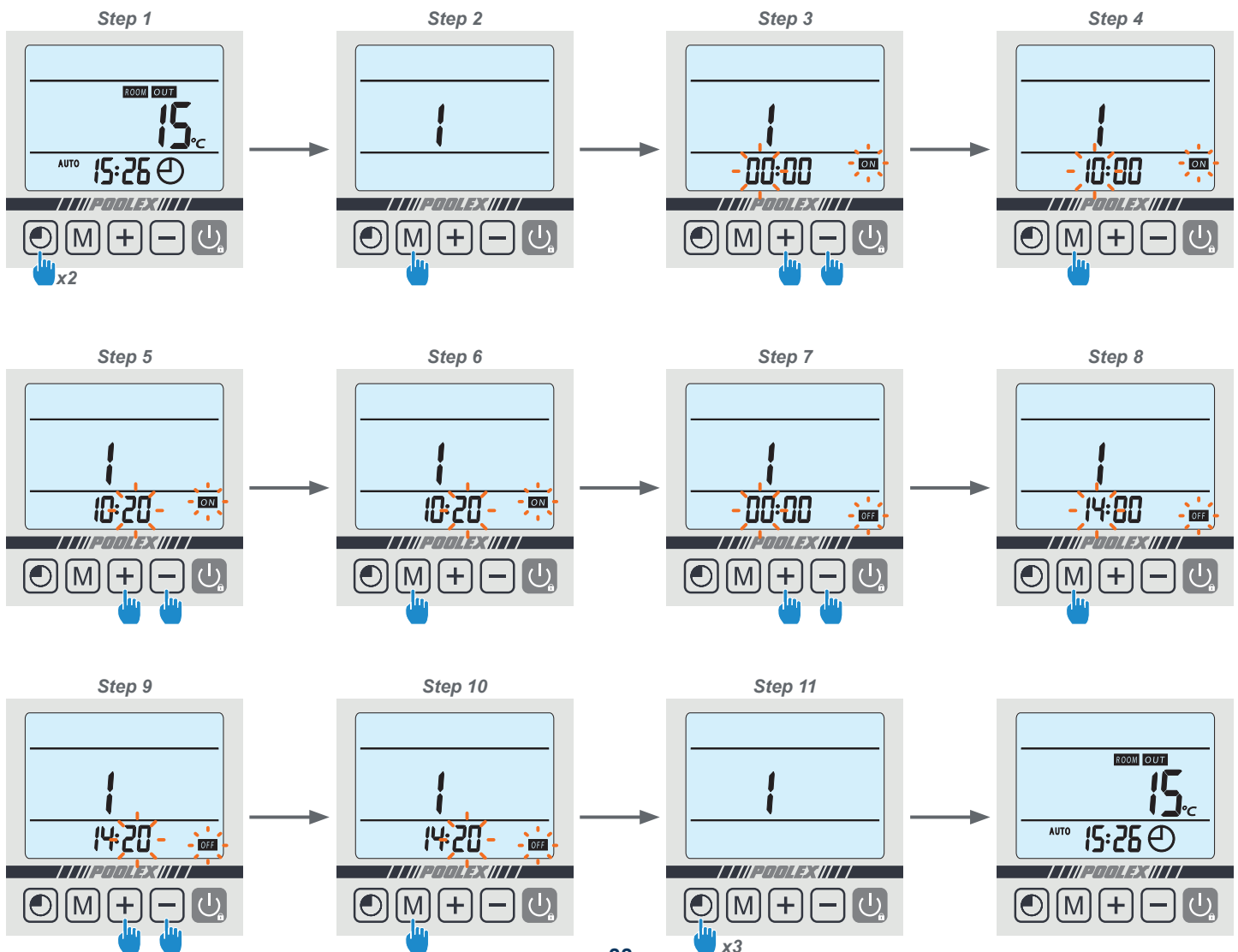



4. Use

4.6 Activating a programme

Once the programme has been defined, it can be activated as follows:

Step 1: Select the programme to be activated,

- Press twice  to select programme 1.
- Press 3 times  to select programme 2.
- Press 4 times  to select programme 3.

Step 2: Keep pressing  until the ON/OFF indicator lights are displayed and start flashing.

Step 3: Press  to return to the main screen.

The ON/OFF lights indicate an active programme; the numeral above the line indicates the number of the active programme.

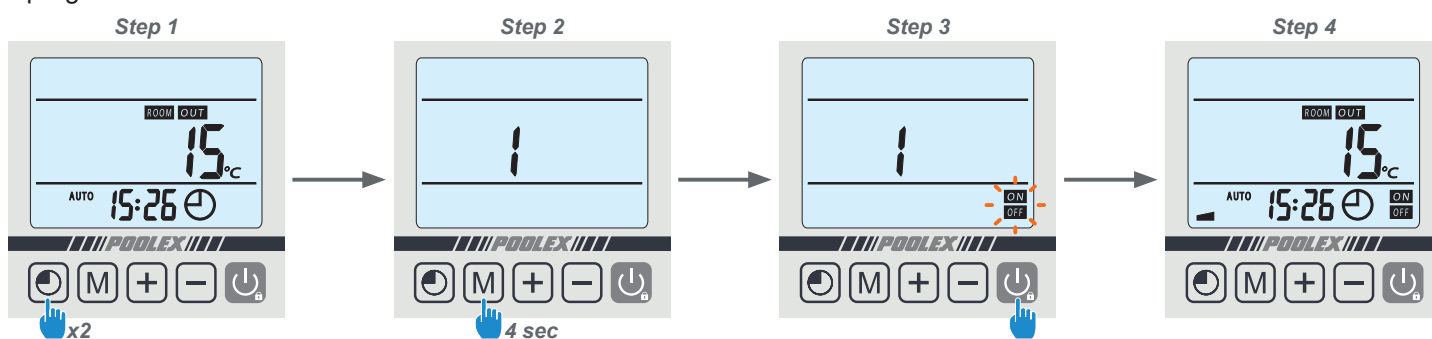

4.7 Deactivating a programme

Once the programme has been activated, it can be deactivated as follows:

Step 1: Select the programme to be deactivated

- Press twice  to select programme 1.
- Press 3 times  to select programme 2.
- Press 4 times  to select programme 3.

Step 2: Keep pressing  until the ON/OFF indicator lights disappear

Step 3: Press  to return to the main screen

The ON/OFF lights indicate an active programme; the numeral above the line indicates the number of the active programme.

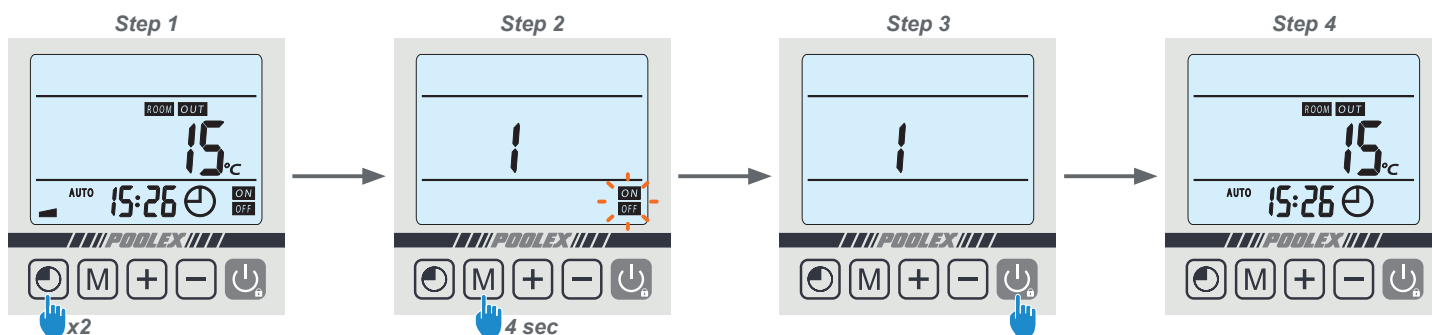

4. Use

4.8 Status values and advanced settings



WARNING: This operation is used to assist servicing and future repairs.
The default settings should only be modified by an experienced professional person.

The system's settings can be checked and adjusted via the remote control by following these steps

Step 1: Keep pressing **[M]** until you enter the settings verification mode.

Step 2: Press several times **[CLOCK]** to reach the setting to be adjusted.

Step 3: Press **[M]** to select the setting to be modified.

NOTE. Some settings cannot be modified. Consult the settings table for further information.

Step 4: Press **[-]** and **[+]** to adjust the setting value.

Step 5: Press **[M]** to set the new value.

Step 6: Press **[-]** and **[+]** to return to the main screen.

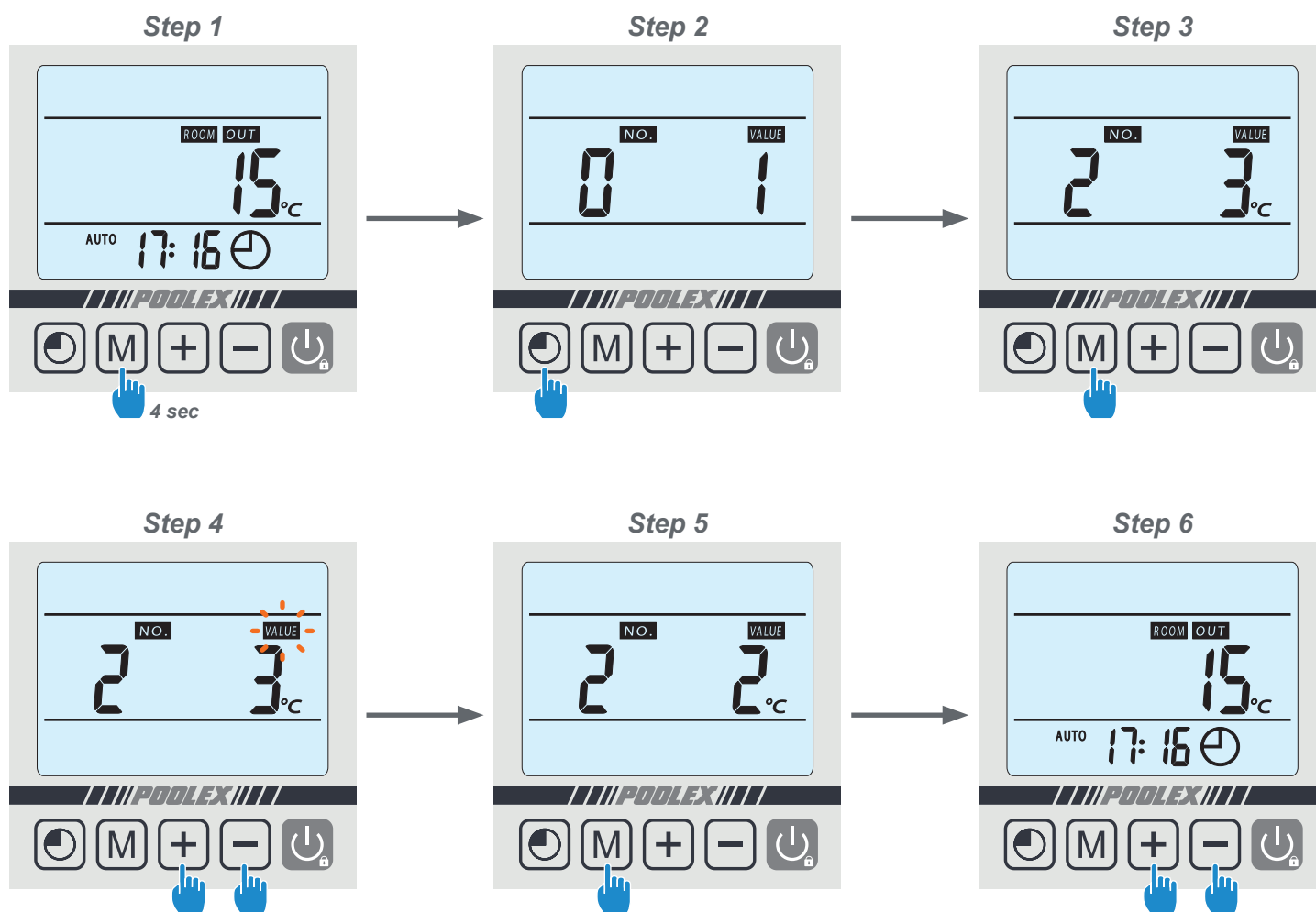

4. Use

Parameters table

N°	Description	Adjustment range	Factory setting	Remarks
0	Automatic restart	0 = Off 1 = On	1	Adjustable
1	START/STOP times programming	0 = start only 1 = daily	1	Adjustable
2*	Adjustment of temperature difference for restart	Adjustable from 2 to 10°C	3°C	Adjustable
3**	Adjustment of compressor shutdown margin	Adjustable from 0 to 3°C	0°C	Adjustable
4	Auto-activation time before de-icing commences	Adjustable from 30 to 90 mins	40 mins	Adjustable
5	De-icing activation temperature	Adjustable from 0 to -30°C	0°C	Adjustable
6	De-icing deactivation temperature	Adjustable from 2 to 30°C	2°C	Adjustable
7	Maximum de-icing duration	Adjustable from 0 to 15 mins	10 mins	Adjustable
8	Compressor thermal protection	Adjustable from 95 to 120°C Displayed values 95 → 9b → 97 → 98 → 99 → A0 → A1 → A2 → A3 → A4 → A5 → Ab → A7 → AB → A9 → b0 → b1 → b2 → b3 → b4 → b5 → bb → b7 → b8 → b9 → C0	118°C Displayed value b8	Adjustable
9	Maximum temperature	40~65°C	40°C	Adjustable
10	Filtration pump servo-control mode	0 = Normal 1 = Special	1	Adjustable (see Section 5.2)
11	Pump stopping time when temperature reached (if setting 10 = 1)	Adjustable from 3 to 20 mins	15 mins	Adjustable
12	Reserved - Do not modify	0 / 1	1	Adjustable
13	Reserved - Do not modify	0 / 1 / 2	2	Adjustable
14	Water intake temperature	-9~99°C		Actual data
15	Water outlet temperature	-9~99°C		Actual data
16	Coil temperature	-9~99°C		Actual data
17	Air outlet temperature	-9~99°C		Actual data
18	Ambient air temperature	-9~99°C		Actual data

* **Setting 2 is for modifying the interval of degrees lost in relation to the required temperature, for the heat pump to restart.**
Example: If the value of setting 2 is 3°C, after reaching the required temperature (e.g. e.g. 27°C), the heat pump will restart when the pool temperature goes down to 24°C (27 - 3).

** **Setting 3 is for modifying the degree of accuracy for heat pump shutdown.**
Example: By configuring the compressor shutdown at 2°C and the required temperature at 27°C, the heat pump will cease working when it reaches a pool temperature of 29°C (27+2).

5. Operation

5.1 Operation

Conditions of use

For the heat pump to operate normally, the ambient air temperature must be between 7°C and 43°C.

Recommendations prior to start-up

Before activating the heat pump, please:

- ▶ Check that the unit is firmly secured and stable.
- ▶ Check that the gauge indicates a pressure greater than 80 psi.
- ▶ Check that the electrical wiring is properly connected to the terminals.
- ▶ Check the earthing.
- ▶ Check that the hydraulic connections are tight and that there is no leakage of water.
- ▶ Check that the water is circulating correctly in the heat pump and that the flow rate is adequate.
- ▶ Remove any unnecessary object or tool from around the unit.

Operation

1. Activate the unit's power supply protection (differential switch and circuit-breaker).
2. Activate the circulating pump if it is not servo-controlled.
3. Check the By-Pass opening and the control valves.
4. Activate the heat pump by pressing once on 
5. Adjust the remote control clock.
6. Select the required temperature by using one of the remote control's modes.
7. The heat pump's compressor will start up after a few moments.

All you have to do now is wait until the required temperature is reached.

WARNING: Under normal conditions, a suitable heat pump can heat the water in a swimming pool by 1°C to 2°C per day. It is therefore quite normal to not feel any temperature difference in the system when the heat pump is working.
A heated pool must be covered to avoid any loss of heat.



5. Operation

5.2 Servo-control of circulating pump

If you have connected a circulating pump to terminals P1 and P2, it is automatically electrically powered when the heat pump operates.

When the heat pump is on standby, the circulating pump is powered intermittently in order to monitor the water temperature in the pool.

Servo-control mode for circulating pump (Setting 10)

When you activate your heat pump, the circulating pump starts up, followed 1 minute later by the heat pump compressor. When the heat pump stops working, its compressor and fan shut down, and the circulating pump stops after 30 seconds. During a de-icing cycle, the circulating pump will continue to operate irrespective of the selected mode.

Mode 0: By selecting this mode, the heat pump will automatically put the circulating pump into continuous operation. Once the circulating pump is operating, the heat pump will start up 1 minute later. Next, when the required temperature is reached, the heat pump will stop working but will not stop the circulating pump, so as to ensure a constant circulation of water in your heat pump.

Mode 1 (default): This mode has been designed to maintain filtration in your pool without using the timetable programmer. When the required temperature is reached, the heat pump will go on standby, then 30 seconds later the circulating pump will shut down.

The circulating pump will then be reactivated in special mode: 2 minutes operation, 15 minutes shut down (Setting 11 = 15 by default, adjustable from 3 to 20 minutes), thus maintaining regular filtering of your pool. With a temperature sensor in the heat exchanger compartment, this mode allows your heat pump to update your pool's actual temperature every 15 minutes. We therefore recommend this mode.

It is only when the pool temperature goes down by 3°C in relation to the required temperature that the filtration pump and the heat pump resume their normal operating mode.

5.3 Using the pressure gauge

The gauge is for monitoring the pressure of the refrigerant contained in the heat pump. The values it indicates can vary considerably, depending on the climate, temperature and atmospheric pressure.

When the heat pump is in operation:

The gauge's needle indicates the refrigerant pressure.

Mean operating range between 250 and 400 PSI, depending on the ambient temperature and atmospheric pressure.

When the heat pump is shut down:

The needle indicates the same value as the ambient temperature (within a few degrees) and the corresponding atmospheric pressure (between 150 and 350 PSI maximum).

If left unused for a long period of time :

Check the pressure gauge before starting up the heat pump. It must indicate at least 80 PSI.

If the pressure goes down too much, the heat pump will display an error message and automatically go into 'safe' mode.

This means that there has been a leakage of refrigerant and that you must call a qualified technician to replace it.

5. Operation

5.4 Antifreeze protection



WARNING: For the antifreeze system to work, the heat pump must be powered and the circulating pump activated. If the circulating pump is servo-controlled by the heat pump, it will be automatically activated.

When the heat pump is on standby, the system monitors the ambient temperature and the water temperature in order to activate the antifreeze programme if required.

The antifreeze programme is automatically activated when the ambient temperature or the temperature of the water is less than 2°C and when the heat pump has been shut down for more than 120 minutes.

When the antifreeze programme is running, the heat pump activates its compressor and the circulating pump so as to reheat the water until the water temperature exceeds 2°C.

The heat pump automatically leaves the antifreeze mode when the ambient temperature is greater than or equal to 2°C or when the heat pump is activated by the user.

6. Maintenance and servicing

6.1 Maintenance and servicing



WARNING: Before undertaking maintenance work on the unit, ensure that you have disconnected the electrical power supply.

Cleaning

The heat pump's casing must be cleaned with a damp cloth. The use of detergents or other household products could damage the surface of the casing and affect its properties.

The evaporator at the rear of the heat pump must be carefully cleaned with a vacuum cleaner and soft brush attachment.

Annual maintenance

The following operations must be undertaken by a qualified person at least once a year.

- ▶ Carry out safety checks.
- ▶ Check the integrity of the electrical wiring.
- ▶ Check the earthing connections.
- ▶ Monitor the state of the pressure gauge and the presence of refrigerant.

6.2 Winter storage

In the winter months when the ambient temperature is lower than 3°C, a shut-down heat pump must be winterised to avoid any frost damage.

Winterising in 4 steps



Step 1
Disconnect the heat pump from the power supply.

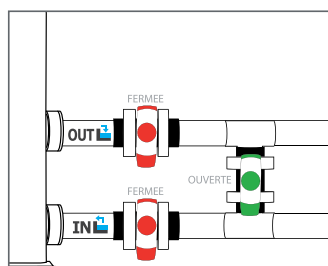

Step 2
Open the By-Pass valve. Close the inlet and outlet valves.

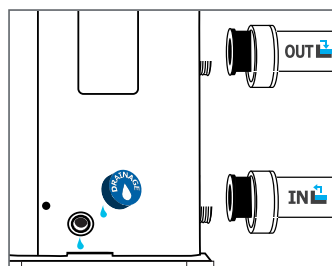

Step 3
Unscrew the drain plug and water pipes in order to drain any water from the heat pump.

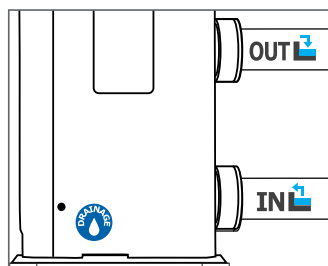

Step 4
Screw back the drain plug and pipes or block them with rags so as to prevent any foreign bodies from getting into the circuit. Finally, protect the pump with its winter storage cover.



If a circulating pump is servo-controlled by the heat pump, drain this also.

7. Repairs



WARNING: Under normal conditions, a suitable heat pump can heat the water in a swimming pool by 1°C to 2°C per day. It is therefore quite normal to not feel any temperature difference in the system when the heat pump is working.
A heated pool must be covered to avoid any loss of heat.

7.1 Breakdowns and faults

In the event of a problem, the heat pump's screen displays a fault symbol  instead of temperature indications. Please consult the table opposite to find the possible causes of a fault and the actions to be taken.

Fault code examples:

Fault code P1

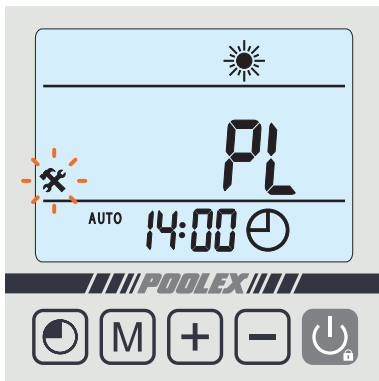

Fault code P1

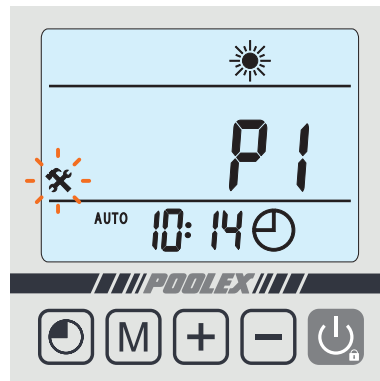

Fault code P2

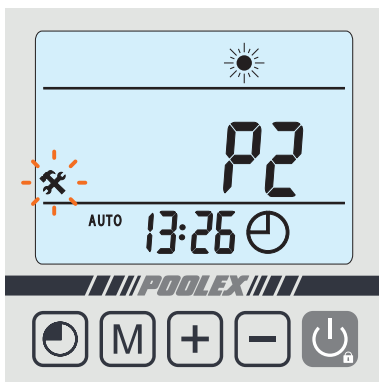

Fault code P7

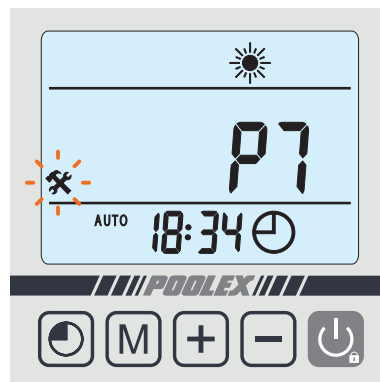

7. Repairs

7.2 List of faults

Code	Fault	Possible causes	Action
P3	Water intake temperature sensor malfunction	1) Sensor badly connected	1) Reconnect sensor
		2) Sensor defective	2) Replace sensor
		3) PCB defective	3) Replace PCB
P4	Water outlet temperature sensor malfunction	Same causes as P3	Same actions as P3
P1	De-icing temperature sensor malfunction		
P7	External temperature sensor malfunction		
P2	Air venting sensor malfunction		
PB	Water temperature at outlet too low for cooling mode	1) Water flow rate too low	1) Check water filter and hydraulic circuit
		2) Water temperature at intake too low	2) Adjust temperature
		3) Defective PCB	3) Replace PCB
PC	Antifreeze protection	Protection activated when the ambient temperature is too low and the unit is on standby	No intervention is necessary
E4	High pressure protection	1) Insufficient water flow	1) Check water pump operation and openings of By-Pass inlet/outlet valves
		2) Defective 4-way valve or excess refrigerant	2) Readjust the quantity of refrigerant
		3) Water temperature setting too high	3) Set the required temperature to 5°C above the current temperature then proceed in increments of 5°.
		4) Pressure switch disconnected or defective	4) Reconnect or replace pressure switch
		5) Defective PCB	5) Replace PCB
P9	Low pressure protection	1) Insufficient refrigerant	1) Readjust the quantity of refrigerant
		2) Defective 4-way valve	2) Replace valve
		3) Pressure switch disconnected or defective	3) Reconnect or replace pressure switch
		4) Defective PCB	4) Replace PCB
PL	Flow sensor malfunction	1) Insufficient water in heat exchanger	1) Check your water circuit operation and the opening of the By-Pass valves
		2) Defective water flow sensor	2) Replace water flow contactor
		3) Defective PCB	3) Replace PCB
Pb	Excessive difference between water inlet temperature and water outlet temperature	1) Water flow rate too low	1) Check water pump and hydraulic system operation, and the opening of the By-Pass inlet/outlet valves
		2) Defective PCB	2) Replace PCB
E3	Vented air temperature too high	1) Insufficient refrigerant gas	1) Readjust the quantity of refrigerant
		2) Same causes as fault E4	2) Same actions as fault E4
Eb	Thermal protection	1) Water flow too low or water intake temperature too high	1) Check water flow or adjust water temperature
		2) Defective thermal protection	2) Replace protection
		3) Bad connection	3) Check connections
		4) Defective PCB	4) Replace PCB
EB	Problem with connection between PCB and wired remote control	1) Bad connection	Check wiring connections between remote control and PCB
		2) Defective wired remote control	2) Replace remote control
		3) Defective PCB	3) Replace PCB

9. Warranty

9.1 General warranty conditions

The Poolstar Company guarantees the original owner against defective materials and faults in the manufacture of the Poolex Jetblack heat pump for a period of three (3) years.

The compressor is guaranteed for a period of five (5) years.

The titanium tube heat exchanger is guaranteed for a period of fifteen (15) years against chemical corrosion, except for frost damage.

The condenser's other components are guaranteed for two (2) years.

The warranty becomes effective on the date of the first invoice.

The warranty does not apply in the following cases:

- Malfunction or damage arising from an installation, usage or repair that is not in compliance with the safety instructions.
- Malfunction or damage arising from a chemical agent that is unsuitable for the pool.
- Malfunction or damage arising from conditions that are unsuitable for the equipment's purposes of use.
- Damage arising from negligence, accident or force majeure.
- Malfunction or damage arising from the use of unauthorised accessories.

Repairs undertaken during the warranty period must be approved prior to being carried out by an authorised technician. The warranty shall be null and void if the repair to the equipment is carried out by a person who is not authorised by the Poolstar company.

The guaranteed parts shall be replaced or repaired at Poolstar's discretion. Defective parts must be returned to our workshops to be covered during the warranty period. The warranty does not cover labour costs or unauthorised replacements. The return of the defective part is not covered by the warranty.

Dear Sir/Madam,

Please spend a few minutes filling in the warranty registration card that you will find on our website:

<http://support.poolex.fr/>

We thank you for your trust in our products.
Enjoy your swimming!

Your details may be treated in accordance with the Data Protection Act of 6 January 1978 and will not be divulged to any third party.

WARNING:

The contractual warranty cannot be validated with the installer or Poolstar unless your product has been registered on our website.

10. Appendices

10.1 Wiring diagrams

Poolex Jetblack MINI / 55 / 70 / 90

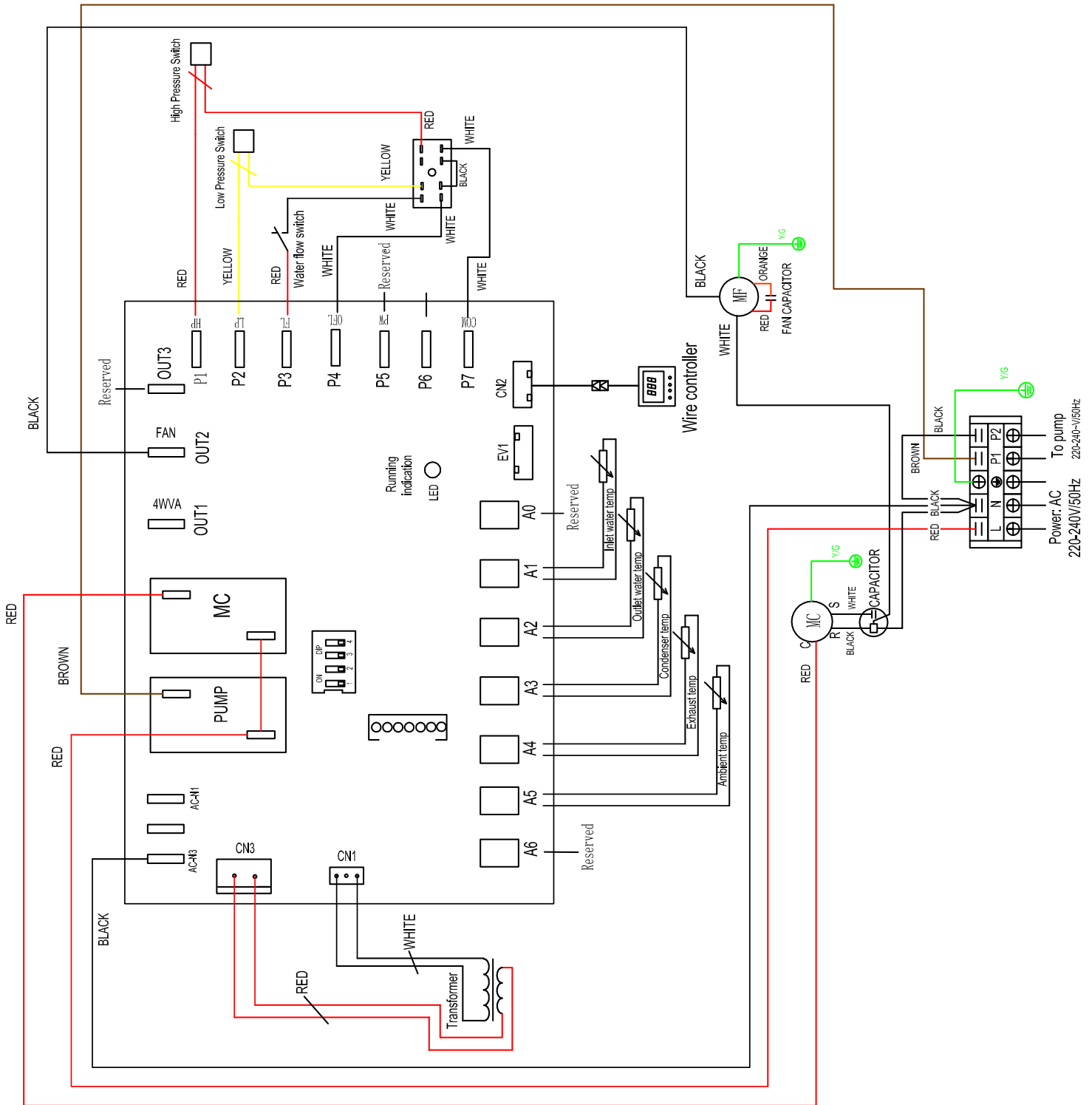

10. Appendices

Poolex Jetblack 120 / 150 / 180

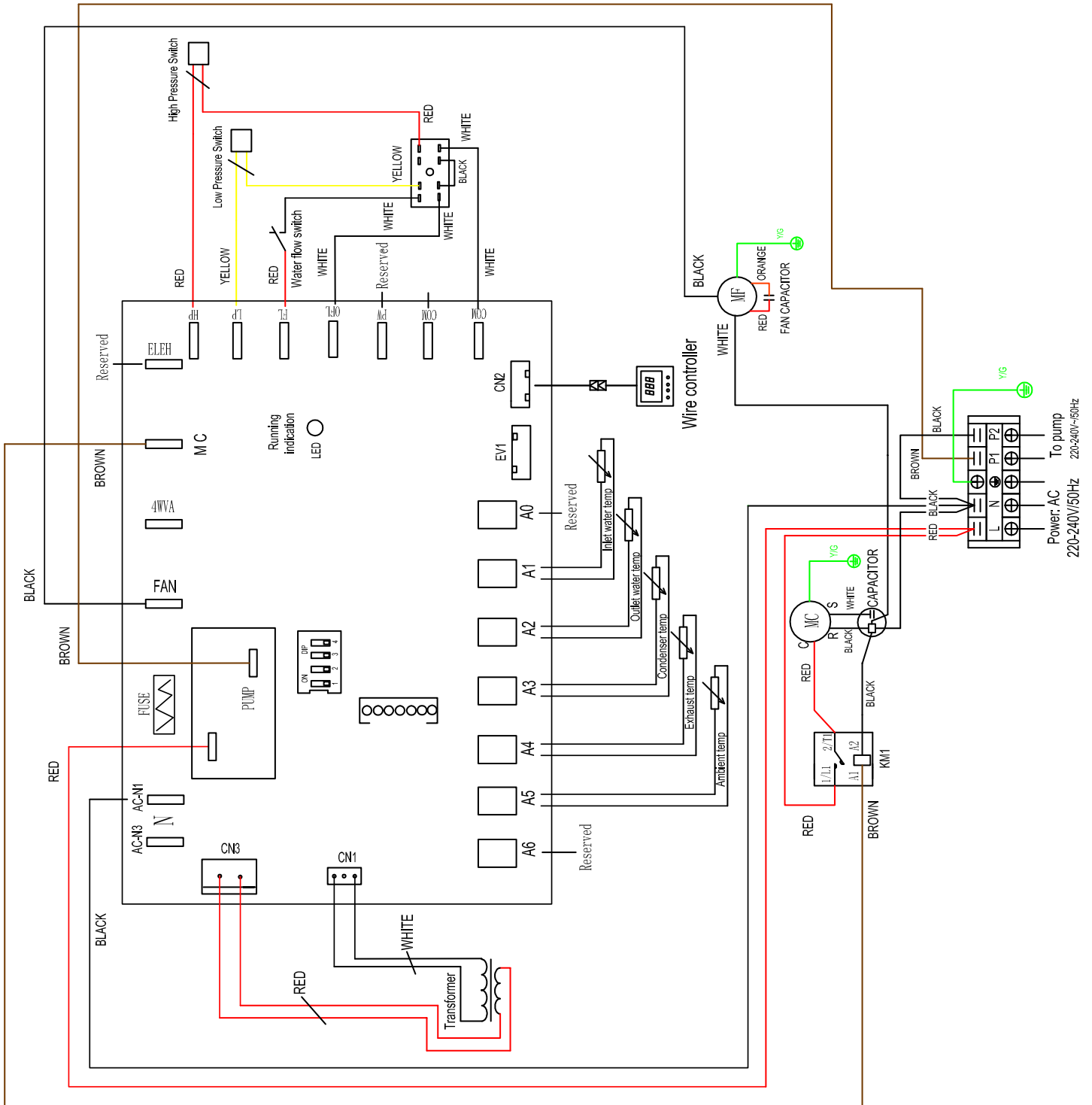

POOLEX

TECHNICAL SUPPORT
www.poolex.co.uk



Poollex is a Poolstar Group trademark
www.poolstar.fr

